



A9 – A110

- Maximum UL/CSA horsepower ratings
- Includes NEMA sizes 00 – 3
- CE mark
- Compact space saving design
- Standard auxiliary contact configurations:
A9 – A40 1 N.O. or 1 N.C.
A50 – A110 1 N.O. and 1 N.C.
Can be supplied without auxiliaries
- Additional auxiliary contact blocks are available
- D.C. ratings & D.C. control operation available
- Fast, snap-on DIN rail mounting
- Double break contact design
- Snap-on front mounted accessories include mechanical latch, pneumatic timer, and 1 & 4 pole auxiliary contact blocks
- Common accessories for A9 – A110 contactors
- Complete range of 4 pole contactors 21A – 105A
- Easy coil change
- Captive terminal screws
- NEMA, UL, IEC, CSA, VDE and most other international standards
- UL File No: E39231 (A9 – A75)
- UL File No: E79416 (A95 – A110)
- CSA File No: LR56745 (A9 – A75)
- CSA File No: LR19700 (A95 – A110)
- Touch safe design: All connection terminals are protected against accidental touch
- Terminals supplied open for ease of wiring
- Operates over an extended voltage range of 85% to 110% of rated control voltage
- Screwdriver guide holes

Index

• Features	1.1
• Description	1.2 – 1.3
• Non-reversing	1.4 – 1.5
• Mechanically interlocked	1.6
• Reversing	1.7
• For capacitor switching	1,8
• Accessories	1.9 – 1.17
• Technical data	1.18 – 1.28
• Motor data	1.29
• Approximate dimensions	1.30 – 1.40

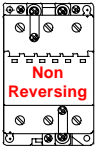

Non-reversing contactors

3 pole, AC & DC operated

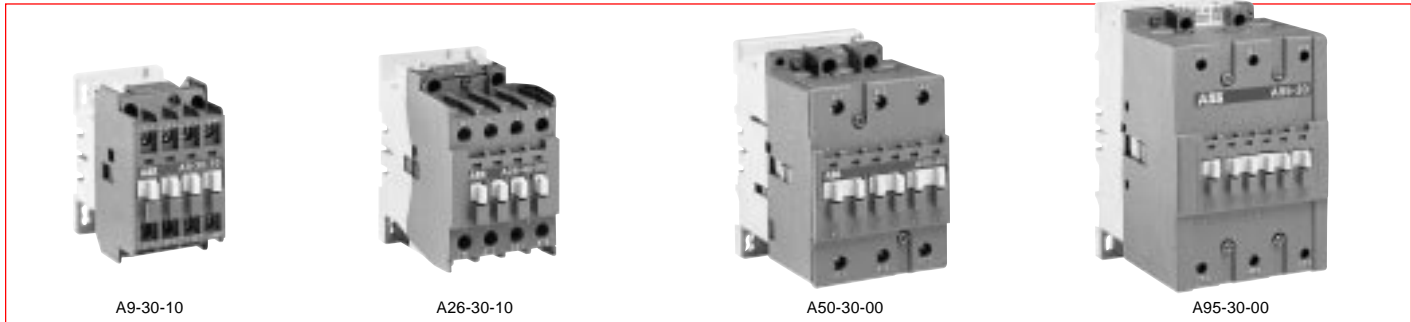

Contactors

General purpose current			Maximum motor horsepower ratings ^{UL} ^{CS}				Standard Aux. contacts		AC operated		DC operated	
AC oper.	DC oper.	Motor switching current	208V	240V	480V	575/600V	N.O.	N.C.	Catalog number	List price	Catalog number	List price
AC1	AC1	AC3	UL rated									
21	—	9	2	2	5	7.5	1 0	0 1	A9-30-10-84 A9-30-01-84	\$ 78	BC9-30-10-04 BC9-30-01-04	\$ 123
25	—	11	3	3	7.5	10	1 0	0 1	A12-30-10-84 A12-30-01-84	84	—	—
30	21	17	5	5	10	15	1 0	0 1	A16-30-10-84 A16-30-01-84	102	BC16-30-10-04 BC16-30-01-04	147
40	33	28	7.5	10	20	25	1 0	0 1	A26-30-10-84 A26-30-01-84	183	BC25-30-10-04 BC25-30-01-04	228
50	45	32	10	10	25	30	1 0 0 2	0 1 0 2	A30-30-10-84 A30-30-01-84 — —	252 — —	BC30-30-00-04 BC30-30-22-04	267 297
60	—	41	10	15	30	40	1 0	0 1	A40-30-10-84 A40-30-01-84	297	—	—
80	—	54	15	20	40	50	0 1	0 1	A50-30-00-84 A50-30-11-84	300 330	AE50-30-00-04 AE50-30-11-04	345 375
90	—	65	20	25	50	60	0 1	0 1	A63-30-00-84 A63-30-11-84	342 372	AE63-30-00-04 AE63-30-11-04	447 477
105	—	80	25	30	60	75	0 1	0 1	A75-30-00-84 A75-30-11-84	383 413	AE75-30-00-04 AE75-30-11-04	488 518
125	—	95	30	30	60	75	0 1	0 1	A95-30-00-84 A95-30-11-84	420 450	AE95-30-00-04 AE95-30-11-04	525 555
140	—	110	30	40	75	100	0 1	0 1	A110-30-00-84 A110-30-11-84	450 480	AE110-30-00-04 AE110-30-11-04	660 690

NEMA rated												
NEMA size	Continuous current	1.5	1.5	2	2	1	0					
00	9	1.5	1.5	2	2	1	0	A9N00-30-10-84	\$ 78	BC9N00-30-10-04	\$ 123	
0	18	3	3	5	5	1	0	A16N0-30-10-84	102	BC16N0-30-10-04	147	
1	27	7.5	7.5	10	10	1	0	A26N1-30-10-84	183	BC25N1-30-10-04	228	
2	45	10	15	25	25	1	1	A50N2-30-11-84	330	AE50N2-30-11-04	375	
3	90	25	30	50	50	1	1	A75N3-30-11-84	413	AE75N3-30-11-04	518	

Coil voltage selection

All AC operated catalog numbers include a 120VAC coil. All DC operated catalog numbers include a 110VDC coil. To select other coil voltages, substitute the code from the Coil Voltage Selection Chart for the two digits after the last dash in the catalog number.

Ex.: A 240V coil is required for an A75 contactor: A75-30-00-80

Auxiliary contact blocks

For additional auxiliary contact blocks, see catalog number explanation on page 1.2. Add \$ 20 to list price for each additional auxiliary, and see page 1.18 for available combinations.

Coil voltage selection chart

Hz	Cntr type	Volts															
		12	24	48	110	120	125	208	220	240	277	380	415	440	480	500	600
60	A		81	83	84	84		34	75	80	42	48	86	86	51	53	55
50	A		81	83	84				80			85	86			55	
DC	BC	07	01	16	04		27		05	33							
DC	AE	80	81	83	86		87		88	89							

For other voltages, see page 1.13

Non-reversing contactors

4 pole, AC & DC operated

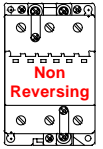

A9-40-00



A26-40-00

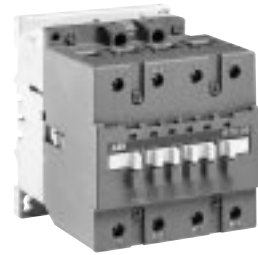

A75-40-00

4 Pole

UL general purpose current		Standard		AC operated		DC operated	
AC operated	DC operated	Auxiliary contacts		Catalog number	List price	Catalog number	List price
21	—	0	0	A9-40-00-84	\$ 120	BC9-40-00-04	\$ 165
30	21	0	0	A16-40-00-84	165	BC16-40-00-04	210
40	30	0	0	A26-40-00-84	228	BC25-40-00-04	273
65	—	0	0	A45-40-00-84	360	AE45-40-00-04	420
80	—	0	0	A50-40-00-84	413	AE50-40-00-04	473
105	—	0	0	A75-40-00-84	525	AE75-40-00-04	570

4 Pole – 2 N.O. & 2 N.C. power poles

UL general purpose current		Standard		AC operated		DC operated	
AC operated	DC operated	Auxiliary contacts		Catalog number	List price	Catalog number	List price
21	—	0	0	A9-22-00-84	\$ 120	BC9-22-00-04	\$ 165
30	21	0	0	A16-22-00-84	165	BC16-22-00-04	210
40	30	0	0	A26-22-00-84	228	BC25-22-00-04	273
65	—	0	0	A45-22-00-84	360	AE45-22-00-04	420
105	—	0	0	A75-22-00-84	525	AE75-22-00-04	570

Coil voltage selection

All AC operated catalog numbers include a 120VAC coil. All DC operated catalog numbers include a 110VDC coil. To select other coil voltages, substitute the code from the Coil Voltage Selection Chart for the two digits after the last dash in the catalog number.

Ex.: A 240V coil is required for an A75 contactor:

A75-22-00-**80**

Auxiliary contact blocks

For additional auxiliary contact blocks, see catalog number explanation on page 1.2. Add \$20 to list price for each additional auxiliary, and see page 1.18 for available combinations.

Coil voltage selection chart

Hz	Cntr type	Volts															
		12	24	48	110	120	125	208	220	240	277	380	415	440	480	500	600
60	A	81	83	84	84		34	75	80	42	48	86	86	51	53	55	
50	A	81	83	84				80			85	86				55	
DC	BC	07	01	16	04		27		05	33							
DC	AE	80	81	83	86		87		88	89							

For other voltages, see page 1.13

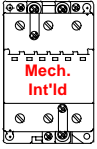

Mechanically interlocked contactors

3 pole, AC & DC operated

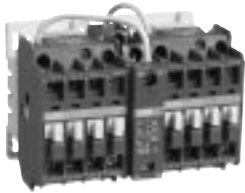

A12M-30-10-84

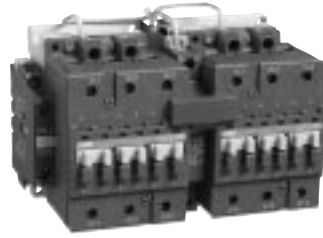

A75M-30-11-84



AE110M-30-11-84

Contactors

General purpose current		Motor switching current	Maximum motor horsepower ratings ^{UL} ^{CS}				Standard		AC operated		DC operated	
AC oper.	DC oper.		208V	240V	480V	575/600V	Auxiliary contacts each contactor		Catalog number	List price	Catalog number	List price
AC1	AC1	AC3	UL rated									
21	—	9	2	2	5	7.5	1 0	0 1	A9M-30-10-84 A9M-30-01-84	\$ 255	BC9M-30-10-04 BC9M-30-01-04	\$ 345
25	—	11	3	3	7.5	10	1 0	0 1	A12M-30-10-84 A12M-30-01-84	315	— —	— —
30	21	17	5	5	10	15	1 0	0 1	A16M-30-10-84 A16M-30-01-84	345	BC16M-30-10-04 BC16M-30-01-04	435
40	33	28	7.5	10	20	25	1 0	0 1	A26M-30-10-84 A26M-30-01-84	405	BC25M-30-10-04 BC25M-30-01-04	495
50	45	32	10	10	25	30	1 0	0 1	A30M-30-10-84 A30M-30-01-84	548	BC30M-30-10-04 BC30M-30-01-04	668
60	—	41	10	15	30	40	1 1	0 1	A40M-30-10-84 A40M-30-11-84	639	— —	— —
80	—	54	15	20	40	50	1	1	A50M-30-11-84	713	AE50M-30-11-04	803
90	—	65	20	25	50	60	1	1	A63M-30-11-84	870	AE63M-30-11-04	1080
105	—	80	25	30	60	75	1	1	A75M-30-11-84	1155	AE75M-30-11-04	1365
125	—	95	30	30	60	75	1	1	A95M-30-11-84	1230	AE95M-30-11-04	1440
145	—	110	30	40	75	100	1	1	A110M-30-11-84	1365	AE110M-30-11-04	1785

NEMA rated

NEMA size	Continuous current											
00	9	1.5	1.5	2	2	1 0	0 1	A9N00M-10-84 A9N00M-01-84	\$ 255	BC9N00M-10-04 BC9N00M-01-04	\$ 345	
0	18	3	3	5	5	1 0	0 1	A16N0M-10-84 A16N0M-01-84	345	BC16N0M-10-04 BC16N0M-01-04	435	
1	27	7.5	7.5	10	10	1 0	0 1	A26N1M-10-84 A26N1M-01-84	405	BC25N1M-10-04 BC25N1M-01-04	495	
2	45	10	15	25	25	1	1	A50N2M-11-84	713	AE50N2M-11-04	803	
3	90	25	30	50	50	1	1	A75N3M-11-84	1155	AE75N3M-11-04	1365	

Description

Mechanically interlocked contactors are designed for reversing, 2 speed, reduced voltage, etc. type starter applications. The complete assembly consists of two mechanically and electrically interlocked contactors mounted as follows with line and load terminals:

- A9 – A16 – mounted on 35mm DIN rail
- A26 – A110 – mounted on common baseplate

Power wiring is **not included**.

The N.C. electrical interlock is provided with the mechanical interlock.

A95 & A110 contactors have the N.C. electrical interlocks provided in the mechanical interlock.

Auxiliary contact blocks

For additional auxiliary contact blocks, see catalog number explanation on page 1.2. Add \$20 to list price for each additional auxiliary, and see page 1.18 for available combinations.

Coil voltage selection

All AC operated catalog numbers include a 120VAC coil. All DC operated catalog numbers include a 110VDC coil. To select other coil voltages, substitute the code from the Coil Voltage Selection chart for the two digits after the last dash in the catalog number.

Ex.: A 240V coil is required for an A75N3M-11 contactor: A75N3M-11-80

Coil voltage selection chart

Hz	Cntr type	Volts															
		12	24	48	110	120	125	208	220	240	277	380	415	440	480	500	600
60	A		81	83	84	84		34	75	80	42	48	86	86	51	53	55
50	A		81	83	84				80			85	86			55	
DC	BC	07	01	16	04		27		05	33							
DC	AE	80	81	83	86		87		88	89							

For other voltages, see page 1.13

Reversing contactors

3 pole, AC & DC operated

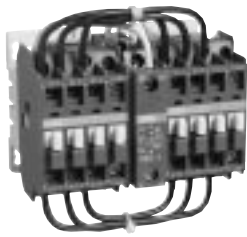
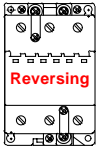

A16R-30-01-83

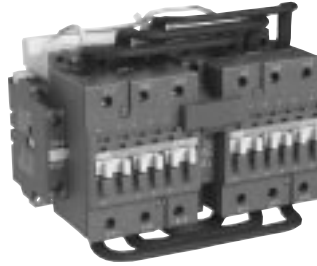

A75R-30-00-83

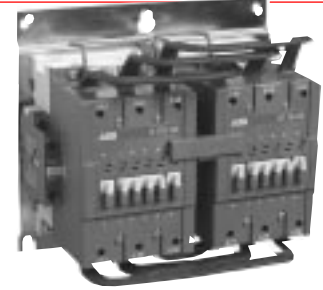

AE110R-30-11-83

General purpose current		Motor switching current	Maximum motor horsepower ratings ^{UL} ^{CS}				Standard		AC operated		DC operated	
AC oper.	DC oper.		208V	240V	480V	575V	Auxiliary contacts each contactor		Catalog number	List price	Catalog number	List price
AC1	AC1	AC3	UL rated									
21	—	9	2	2	5	7.5	1 0	0 1	A9R-30-10-84 A9R-30-01-84	\$ 315	BC9R-30-10-04 BC9R-30-01-04	\$ 405
25	—	11	3	3	7.5	10	1 0	0 1	A12R-30-10-84 A12R-30-01-84	375	— —	— —
30	21	17	5	5	10	15	1 0	0 1	A16R-30-10-84 A16R-30-01-84	413	BC16R-30-10-04 BC16R-30-01-04	503
40	33	28	7.5	10	20	25	1 0	0 1	A26R-30-10-84 A26R-30-01-84	480	BC25R-30-10-04 BC25R-30-01-04	570
50	45	32	10	10	25	30	1 0	0 1	A30R-30-10-84 A30R-30-01-84	623	BC30R-30-10-04 BC30R-30-01-04	743
60	—	41	10	15	30	40	1 1	0 1	A40R-30-10-84 A40R-30-11-84	750	— —	— —
80	—	54	15	20	40	50	1	1	A50R-30-11-84	810	AE50R-30-11-04	930
90	—	65	20	25	50	60	1	1	A63R-30-11-84	1013	AE63R-30-11-04	1208
105	—	80	25	30	60	75	1	1	A75R-30-11-84	1298	AE75R-30-11-04	1493
125	—	95	30	30	60	75	1	1	A95R-30-11-84	1425	AE95R-30-11-04	1635
140	—	110	30	40	75	100	1	1	A110R-30-11-84	1628	AE110R-30-11-04	2048
NEMA rated												
NEMA size	Continuous current											
00	9	1.5	1.5	2	2	1 0	0 1	A9N00R-10-84 A9N00R-01-84	\$ 315	BC9N00R-10-04 BC9N00R-01-04	\$ 405	
0	18	3	3	5	5	1 0	0 1	A16N0R-10-84 A16N0R-01-84	413	BC16N0R-10-04 BC16N0R-01-04	503	
1	27	7.5	7.5	10	10	1 0	0 1	A26N1R-10-84 A26N1R-01-84	480	BC25N1R-10-04 BC25N1R-01-04	570	
2	45	10	15	25	25	1	1	A50N2R-11-84	810	AE50N2R-11-04	930	
3	90	25	30	50	50	1	1	A75N3R-11-84	1298	AE75N3R-11-04	1493	

Contactors

Description

Reversing contactors are designed for reversing type starter applications. The complete assembly consists of two mechanically and electrically interlocked contactors mounted as follows with line and load terminals:

- A9 – A16 — mounted on 35mm DIN rail
- A26 – A110 — mounted on common baseplate

The N.C. electrical interlock is provided with the mechanical interlock.

A95 & A110 contactors have the N.C. electrical interlocks provided in the mechanical interlock.

Auxiliary contact blocks

For additional auxiliary contact blocks, see catalog number explanation on page 1.2. Add \$20 to list price for each additional auxiliary, and see page 1.18 for available combinations.

Coil voltage selection

All AC operated catalog numbers include a 120VAC coil. All DC operated catalog numbers include a 110VDC coil. To select other coil voltages, substitute the code from the Coil Voltage Selection chart for the first digit after the last dash in the catalog number.

Ex.: A 240V coil is required for an A75N3R-11 contactor: A75N3R-11-80

Coil voltage selection chart

Hz	Cntr type	Volts															
		12	24	48	110	120	125	208	220	240	277	380	415	440	480	500	600
60	A		81	83	84	84		34	75	80	42	48	86	86	51	53	55
50	A		81	83	84				80			85	86			55	
DC	BC	07	01	16	04		27		05	33							
DC	AE	80	81	83	86		87		88	89							

For other voltages, see page 1.13

AC 1030 – 6/98

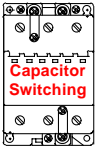

Contactors

for 3 phase capacitor switching

3 pole, AC operated



UA75-30-00-84



UA95-30-00-84

240V	Max kvar switching capacity			Standard auxiliary contacts		Catalog number	List price
	480V	575/600V		N.O.	N.C.		
12.5	25	30		1	0	UA26-30-10-84	\$ 225
16	32	40		1	0	UA30-30-10-84	338
20	40	50		0	0	UA50-30-00-84	345
				1	1	UA50-30-11-84	375
27.5	55	70		0	0	UA75-30-00-84	450
				1	1	UA75-30-11-84	480
35	70	75		0	0	UA95-30-00-84	465
				1	1	UA95-30-11-84	495
40	80	85		0	0	UA110-30-00-84	525
				1	1	UA110-30-11-84	570

For 3 phase capacitors carrying out single bank or stepped bank compensation.

Max. peak current \hat{I} : 100 times the capacitor nominal r.m.s. current at $U_e \leq 500V$ or 90 times for $U_e > 500V$

Electrical durability: 100,000 operating cycles.

Contactor type	Power in kvar 50/60 Hz															Max. permissible peak current \hat{I} (kA)	
	220/240V			380/400/415V			440V			500/550V			660/690V			$U_e \leq 500V$	$U_e > 50C$
	40° C	55° C	70° C	40° C	55° C	70° C	40° C	55° C	70° C	40° C	55° C	70° C	40° C	55° C	70° C		
UA26	12	11	9	20	16.5	14.5	22	22	17	22	22	19.5	30	30	26	3	2.7
UA30	16	16	11	27.5	27.5	19	30	30	20	32	32	23.5	40	40	35	3.5	3.1
UA50	20	20	20	33	32	32	36	35	35	37.5	37.5	37.5	51	51	51	5	4.5
UA75	30	30	25	50	50	40	55	54.5	44	62.5	58.5	47.5	86	80	65	7.5	6.75
UA95	35	35	30	60/65*	60/65*	50/55*	65	65	55	70	70	60	75	75	65	9.3	8
UA110	40	40	35	75	65	60/65*	75	75	70	80	80	75	90	90	85	10.5	9

* Use these values for $U_e = 415V$

Coil voltage selection

All AC operated catalog numbers include a 120VAC coil. All DC operated catalog numbers include a 110VDC coil. To select other coil voltages, substitute the code from the Coil Voltage Selection Chart for the two digits after the last dash in the catalog number.

Ex.: A 240V coil is required for a UA110 contactor: UA110-30-00-80

Auxiliary contact blocks

For additional auxiliary contact blocks, see catalog number explanation on page 1.2. Add \$20 to list price for each additional auxiliary, and see page 1.18 for available combinations.

Coil voltage selection chart

Hz	Cntr type	Volts																	
		12	24	48	110	120	125	208	220	240	277	380	415	440	480	500	600		
60	A	81	83	84	84		34	75	80	42	48	86	86	51	53	55			
50	A	81	83	84				80			85	86			55				

For other voltages, see page 1.13

Accessories for A, AE & BC contactors

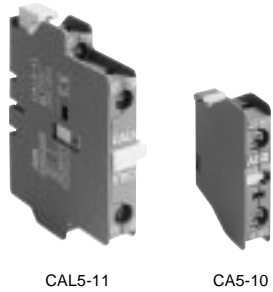
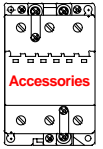

CAL5-11

CA5-10



TP40DA



VE5-1



RV5/50

RC5-1/50



LK75-A

LK75-A1

LK110

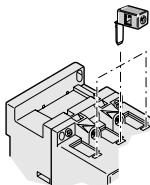

Auxiliary contact blocks

Positioning	Maximum number of contact blocks	Contact Description	Catalog number	List price
Front mounting (single pole)	4 blocks: A9 – A26 BC9 – BC30 5 blocks: A30, A40 6 blocks: A45 – A110 AE45 – AE110	1 N.O. 1 N.C. 1 N.O. Early make 1 N.C. Late break	CA5-10 CA5-01 CC5-10 CC5-01	\$ 15
Front mounting (4 pole)	1 block: A9 – A26-40-00 A30 – A110 AE45 – AE110 BC9 – BC25-40-00 BC30-30-00	4 N.O. 3 N.O. & 1 N.C. 2 N.O. & 2 N.C. 4 N.C. 2 N.O./2 N.C.Ⓞ	CA5-40E CA5-31E CA5-22E CA5-04E CA5-11/11E	30
	1 block: A9 – A40-30-10 BC9 – BC25-30-10	3 N.O. & 1 N.C. 2 N.O. & 2 N.C. 4 N.C. 2 N.O./2 N.C.Ⓞ	CA5-31M CA5-22M CA5-04M CA5-11/11M	
Side mounting (2 pole)	2 blocks: A9 – A110, N 1 block: AE45 – AE110	1 N.O. & 1 N.C.	CAL5-11	

Pneumatic timers

Mounting on	Timing range	Contacts N.O. N.C.	Catalog number	List price
A9 – A75	On delay 0.1 – 40 s	1 1	TP40DA	\$ 108
	On delay 10 – 180 s	1 1	TP180DA	
	Off delay 0.1 – 40 s	1 1	TP40IA	
	Off delay 10 – 180 s	1 1	TP180IA	

Interlocks

Feature	Mounting on	Contacts N.O. N.C.	Catalog number	List price
Mechanical/electrical Mechanical	A9 – A40	— 2	VE5-1	\$ 45
	A50 – A110	— 2	VE5-2	45
	A9 – A40	— —	VM5-1	21

Note: Use type VE 5-2 for mechanical and electrical interlocking between contactors A40 and A50.

Surge suppression device

Feature	Mounting on	Voltage range	Catalog number	List price
Varistor	A9 – A110	24 – 50 VAC	RV5/50	\$ 30
		50 – 133 VAC	RV5/133	
		110 – 250 VAC	RV5/250	
		250 – 440 VAC	RV5/440	
RC	A9 – A40	24 – 50 VAC/DC	RC5-1/50	\$ 30
		50 – 133 VAC/DC	RC5-1/133	
		110 – 250 VAC/DC	RC5-1/250	
		250 – 440 VAC/DC	RC5-1/440	
RC	A45 – A110	24 – 50 VAC/DC	RC5-2/50	\$ 30
		50 – 133 VAC/DC	RC5-2/133	
		110 – 250 VAC/DC	RC5-2/250	
		250 – 440 VAC/DC	RC5-2/440	

Auxiliary lead terminals

Connections	Mounting on	Catalog number	List price
Connects from side Connects from top	A50 – A75	LK75-A	\$ 15
	A50 – A75	LK75-A1	15
Connects from side	A95 – A110	LK110	23

Ⓞ Includes 1 N.O. & 1 N.C. overlapping

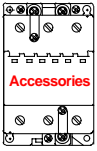

Accessories for A, AE & BC, BE contactors



RA5



RA5 mounted on A75 contactor



RA30 mounted on BC16 contactor



BA5-50



WB75A-04

Interface relay

Mounting on	Coil voltage	Catalog number	List price
A9 – A110	24 VDC	RA5	\$ 75
BC9 – BC30	24 VDC	RA30	

Identification marker

Mounting on	Coil voltage	Catalog number	List price
A9 – A110	Pack of 50	BA5-50	\$ 15

Mechanical latches

For contactors	Catalog number	List price
A, AE & BC, BE [Ⓞ]	WB75A-★	\$ 84

★ - Coil voltage suffix. Refer to Coil Voltage Selection chart and substitute the desired coil voltage suffix for the ★.

Coil voltage selection chart — mechanical latches for B, BC, BE & A, AE contactors

50 Hz	60 Hz	Voltage code
24	24 - 28	01
42	42 - 48	02
48	48 - 55	03
110	110 - 127	04
220 - 230	220 - 255	06
230 - 240	230 - 277	05
380 - 415	380 - 440	07
415 - 440	440 - 480	08

Range: WB75A for contactors A9 – A75, BC9 – BC30, AE45 – AE75 and control relays N and KC.

Description: WB75A block: contains a mechanical latching device with electromagnetic impulse unlatching (AC or DC) or manual unlatching. Captive screw type connecting terminals, built-in cable clamps, M 3.5 (=, -) posidrive 1 screw with screwdriver guidance, delivered untightened and protected against accidental direct contact.

Operation: After closing, the contactor continues to be held in the closed position by the latching mechanism should the supply voltage fail at the contact coil terminals. Contactor opening can be controlled:

• electrically by an impulse* (AC or DC) on the WB75A block coil. The coil is not designed to permanently energized.

- manually by pressing the pushbutton on the front face of the WB75A block.

Mounting: WB75A is clipped onto the front face of the contactor.

[Ⓞ] Excludes A(E)95 & A(E)110.

Accessories for A contactors TE5S Electronic Timer for Wye-Delta starters



TE5S-*

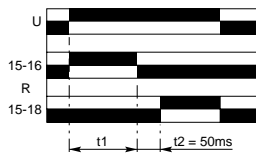

Chart

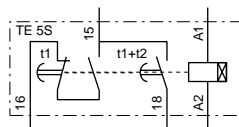

Equivalent diagram

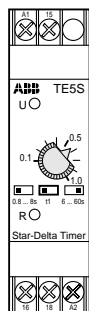

Front face

Electronic timer

For contactors	Rated control voltage U_c V	Packing piece	Unit weight kg	Catalog number	List price
A9 – A110	24 AC/DC	1	0.080	TE5S-24	\$ 120
	110 – 115 AC	1	0.080	TE5S-115	
	220 – 230 AC	1	0.080	TE5S-230	

Application

Utilization

When used in wye-delta starters, the **TE5S** lags the wye connection and provides a lapse of 50 ms before the switchover to the delta connection.

Description

According to the type of device chosen, the electronic circuit has a 24 VAC/VDC, 110 – 120 VAC or 220 – 230 VAC supply. An output relay with reversing contact ensures high current switching. A two-position switch allows selection of one of the two time delay ranges: 0.8 to 8 s or 6 to 60 s. The 0.1 to 1.0 adjustable knob allows an initial setting without steps within the previously selected range which can then be adjusted using a stopwatch.

Note: We recommend that you allow for temperature drift for the final adjustment of the time delay setting. Drift: -0.2% per $^{\circ}\text{C}$. For example, a setting made at 20°C will yield a time delay shorter by 7% at 55°C in an enclosure. (-0.2% per $^{\circ}\text{C}$ i.e. $-0.2 \times 35 = -7\%$).

The **TE5S**, which is not affected by these settings, establishes a fixed “lapse” of 50 ms between the opening of contact 15 – 16 and the closing of contact 15 – 18. It is this time delay that prevents from arc short-circuit during wye to delta switching.

Operation

On energization, the green U indicator light (voltage applied) comes on. Contact 15 – 16 then immediately moves to the closed position.

Count-down of the programmed time immediately commences.

When the time delay has elapsed, contact 15 – 16 opens and at the same time the 50 ms lapse, t_2 , begins after which contact 15 – 18 moves to the closed position. The yellow R indicator light comes on.

On de-energization, the U and R indicator lights go out and, after the 250 ms resetting time, the device is ready for a new cycle.

Mounting

Mounts on 35mm DIN rail.

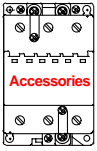

Accessories for A contactors TE5S Electronic Timer for Wye-Delta starters

Technical data

Type	TE5S-24	TE5S-115	TE5S-230
Compliance with standards	IEC 947-5-1, EN 60947-5-1 and VDE 0435		
Rated insulation voltage U_i according to IEC 947-5-1	V 250		
Rated supply voltage U_c	VDC 24	—	—
	VAC 24	110 – 115	220 – 230
Rated frequency limits	Hz 48 – 63		
Supply voltage range	0.85 – 1.1 U_c		
Oversvoltage protection	Built-in varistor		
Load factor	% 100		
Average consumption	in DC in AC	W VA	
	0.7 1.5	— 3.5	— 6.5
Time delay range (t_1) selected by switch	S 0.8 – 8 and 6 – 60		
Temperature drift	% per °C - 0.2		
Mechanical setting accuracy	± 15% of the setting range		
On-load reiteration accuracy under constant conditions	± 2% after 1 million operations		
Minimum time lapse (t_2)	ms 50		
Min. time lapse after 1 million operations	ms 40		
Resetting time (maximum)	ms 250		
Front panel display:	green indicator light yellow indicator light	Energization Output relay activated	
Rated operational voltage U_o acc. to IEC 947-5-1	VDC 24	24 – 230	
	VAC		
Conventional free air thermal current I_{th}	A 10		
Rated operational current I_o acc. to IEC 947-5-1			
DC-13	24 VDC	A	4
AC-15	24 – 115 VAC 220 – 230 VAC	A A	5 4
Permissible air temperature			
for operation	°C	-25 ... +60	
for storage	°C	-40 ... +85	
Mechanical durability in millions of operations	5		
Electrical durability in millions of operations	1		
On-load maximum switching frequency	ops./h 720		
Shock and vibration withstand	on request		
Fixing on mounting rail according to EN 50022	35 x 7.5 or 35 x 15		
Connecting terminals	(+, -) pozidriv 1 screw		
Tightening torque	N.m 0.6 – 0.8 max.		
Connecting capacity			
Rigid solid	1 or 2 x mm²	1 – 2.5	
Flexible without cable end	1 or 2 x mm²	0.75 – 2.5	
Degree of protection acc. to IEC 529, IEC 947-1 and EN 60 529			
Housing	IP 50		
Terminals	IP 20		

Accessories

for A, AE, BC contactors & KC control relays

Coils & coil voltage codes

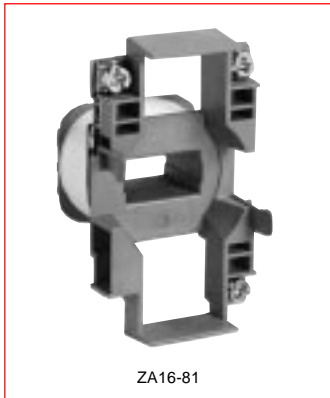
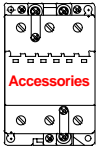

Coils — AC operated

For contactors	Catalog number	List price
A9 – A16	ZA16-★	\$ 24
A26 – A40	ZA40-★	30
A45 – A75	ZA75-★	57
A95 – A110	ZA110-★	60

Coils — DC operated

KC and BC9 – BC30	KBC30G-★	36
AE45 – AE75	ZAE75-★	57
AE95 – AE110	ZAE110-★	90
Auxiliary including an insertion contact and a varistor for DC operated contactors	CDL5-01 AE45 – AE75 AE95 – AE110	45

★ – Coil voltage suffix. Refer to Coil Voltage Selection charts below and substitute the desired coil voltage code for the ★.

Coil voltage selection — AC Operated

for A9 – A110; UA26 – UA95

VAC (50Hz)	VAC (60Hz)	Voltage Code
24	24	81
26	28	16
28	32	17
42	42	82
48	48	83
60	60	73
100	100 – 110	74
110	110 – 120	84
110 – 115	115 – 127	89
120	140	29
125 – 127	150	30
175	208	34
190	220	36

VAC (50Hz)	VAC (60Hz)	Voltage Code
200	200 – 220	75
220 – 230	230 – 240	80
230 – 240	240 – 260	88
230 – 240	277	42
230/400 ^①	—	62
—	230/400 ^①	63
—	380	48
380 – 400	400 – 415	85
400 – 415	415 – 440	86
—	480	51
440	500	53
500	600	55
550	—	56
660 – 690	—	58

Coil voltage selection — DC Operated

for AE & BC contactors; KC control relays

VDC	Voltage code	
	KC Control relays BC Contactors	AE Contactors
12	07	80
24	01	81
42	02	82
48	16	83
50	17	21
60	03	84

VDC	Voltage code	
	KC Control relays BC Contactors	AE Contactors
75	22	85
110	04	86
125	27	87
220	05	88
240	33	89
250	34	38

① Dual voltage coil for N, A9 - A16 only.

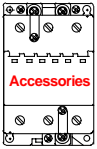

Accessories for A & BC contactors

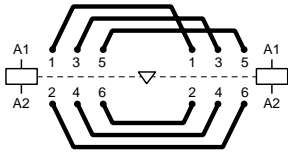

BEM circuit diagram

Connection kits for reversing

Mounting on 3 pole contactors	Catalog number	List price
A9 – A16 A26 A30, A40 A50 – A75 A95, A110	BEM16-30 BEM26-30 BEM40-30 BEM75-30 BEM110-30	\$ 23 30 45 165 180
BC9, BC16 BC25 BC30	BSM16-30 BSM25-30BC BSM30-30BC	23 30 45

Application

Connections between the main poles of **two 3 pole contactors** mounted side by side so that they operate as reversing contactors.

Description

The sets are made up of three reversing connections and three phase to phase connections.

- BEM16-30** — Insulated, solid, rigid copper wires
- BEM26 and 40-30** — Insulated, stranded, rigid copper wires
- BEM75 and 110-30** — Insulated, solid copper bars
- BSM16-30, BSM25 and 30-30BC** — Insulated, solid, rigid copper wires

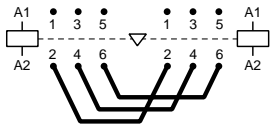

BES110 connection diagram

Connection kits for phase to phase

Mounting on 3 pole contactors	Catalog number	List price
A(E)50, A(E)75 A(E)95, A(E)110	BES75-30 BES110-30	\$ 75 90

Description

This set is made up of three phase to phase bus bars.

Connection kits for wye-delta starters

Mounting on contactors		Catalog number	List price
Line and delta contactor	Wye contactor		
A30 A40	A26 A26	BED40	\$ 53
A50 A63	A30 A40	BED50	165
A75	A50	BED75	180
A95	A75	BED95	195
A110	A95	BED110	225

Application

Connections between the main poles of a wye-delta starter.

Description

These sets are made up of:

- Three line contactor/wye contactor connections — line side.
- Three wye contactor/delta contactor connections — load side.
- The shorting connection for the "S" contactor.

- BED40** — Insulated, stranded, rigid copper wires.
- BED50 – BED110** — Insulated, solid copper bars.

The above connection sets allow a mechanical interlock unit to be mounted between the wye and delta contactors if required.

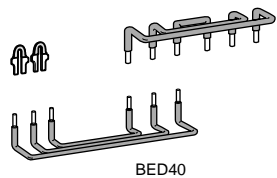

BED40

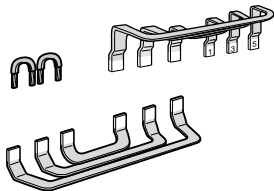

BED75

Accessories for A & AE contactors

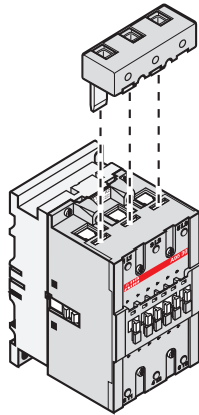
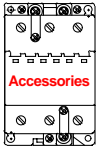

LD110

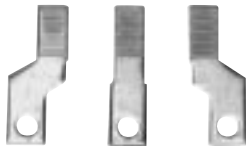

BEXT-75

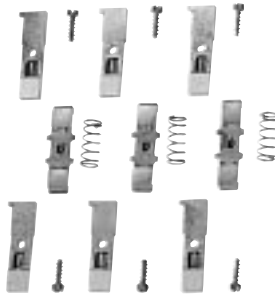

ZL75

Additional terminal block

Mounting on 3 pole contactors	Catalog number	List price
A(E)95 and A(E)110	LD-110	\$ 30

Application

The LD110 terminal block is designed to increase the connection capacity of the contactor on which it is mounted: A(E)95 or A(E)110.

Description

Block housing three connectors: 1 per phase. Each connector is equipped with an HC, M8 socket head screw and has the following connection details:

- Stranded conductor (1) 6–2/0 OR (2) 4–1/0
- Busbar max. width 12 mm

Mounting

The LD110 terminal block can be mounted in the terminal slots located on line or load side of contactor.

Terminal extensions

Mounting on contactors	Dimensions		Catalog number	List price
	Hole Ø mm	Bar mm		
A50 – A75	6.5	12X3	BEXT-75	\$ 15
A(E)95, A(E)110	6	15x3	LW-110	

Application

They are designed to increase the width of the contactor terminal pads to allow larger connectors to be mounted.

Description

Terminal extension sets contain 3 bars.

Contact kits

For contactors	Catalog number	List price
3 Pole		
A/AE	ZL50	\$ 113
A/AE	ZL63	135
A/AE	ZL75	158
A/AE95-30	ZL95	225
A/AE110-30	ZL110	255
4 Pole		
A/AE45-40	ZLT45	150
A/AE50-40	ZLT50	150
A/AE75-40	ZLT75	210

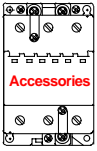

Terminal marking & positioning for A & UA contactors

Standard devices without addition of auxiliary contacts

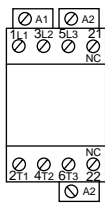

A9 – A40-30-01

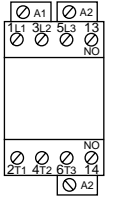

A9 – A40-30-10

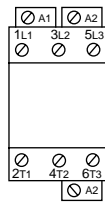

A50 – A110-30-00
UA50 – UA110-30-00

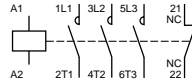

A9 – A40-30-01

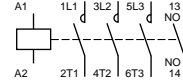

A9 – A40-30-10

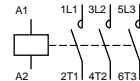

A50 – A110-30-00
UA50 – UA110-30-00

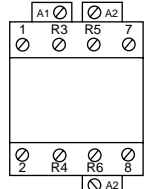

A9 – A26-22-00
A45 – A75-22-00

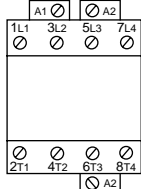

A9 ... A26-40-00
A45 ... A75-40-00

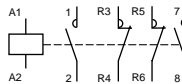

A9 – A26-22-00
A45 – A75-22-00

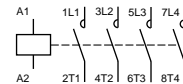

A9 – A26-40-00
A45 – A75-40-00

Standard 3 pole devices with factory mounted auxiliary contacts

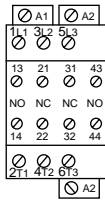

A9 – A16-30-22

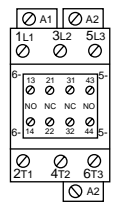

A50 – A110-30-22

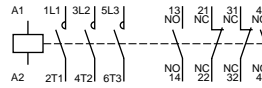

A9 – A16-30-22
A50 – A110-30-22

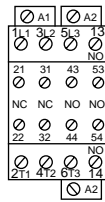

A9 – A40-30-32

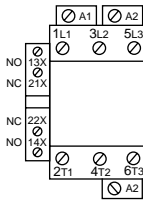

A50 ... A110-30-11
UA50 ... UA110-30-11



A9 – A40-30-32

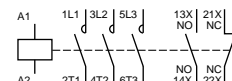

A50 – A110-30-11
UA50 – UA110-30-11

Other possible contact combinations with auxiliary contacts added by the user

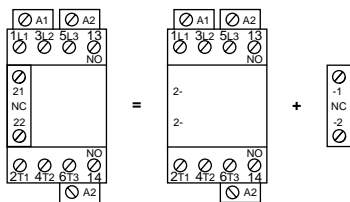

Combination 11 = A9 – A40-30-10 + CA5-01

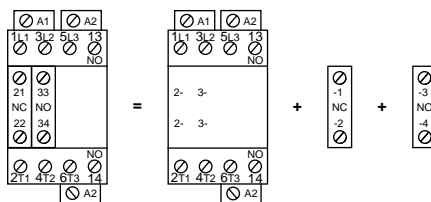

Combination 21 = A9 – A40-30-10 + CA5-01 + CA5-10

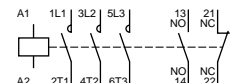

Combination 11

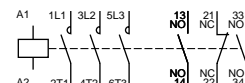

Combination 21

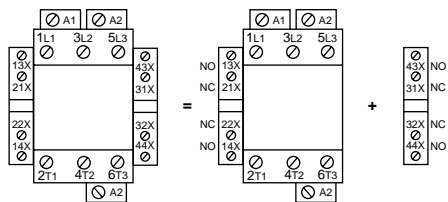

Combination 22 = A50 – A75-30-11 + CAL5-11

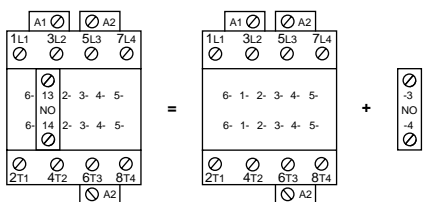

Combination 10 = A45 – A75-40-00 + CA5-10

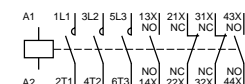

Combination 22

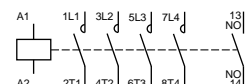

Combination 10

Terminal marking & positioning for AE & BC contactors

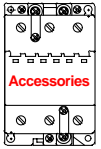

AE Contactors — D.C. Operated

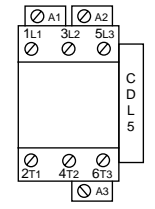

AE50 - AE75-30-00

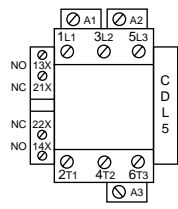

AE50 - AE75-30-11

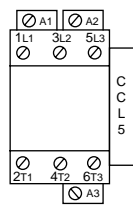

AE95 - AE110-30-00

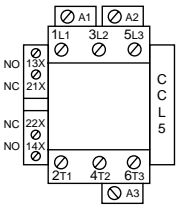
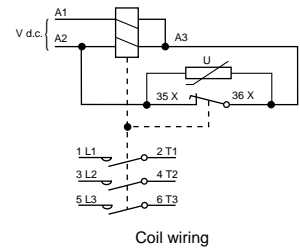
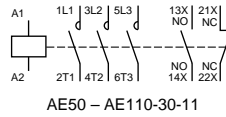
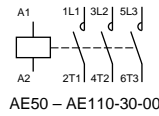

AE95 - AE110-30-11

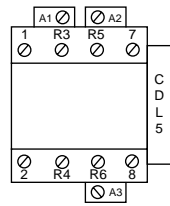

AE45 - AE75-22-00

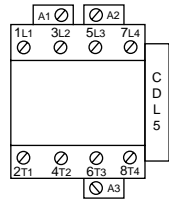

AE45 - AE75-40-00

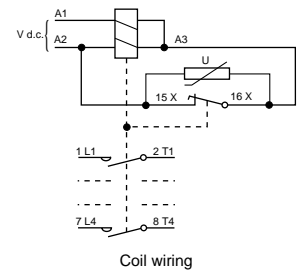
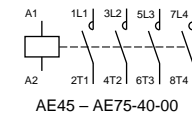
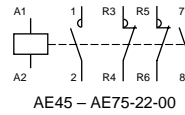

BC Contactors — D.C. Operated

Standard devices without addition of auxiliary contacts

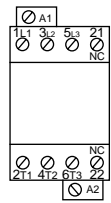

BC9 - BC25-30-01

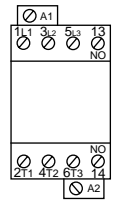

BC9 - BC25-30-10

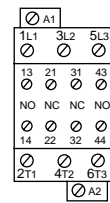

BC30-30-22

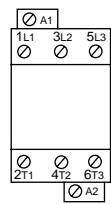
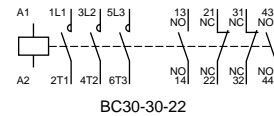
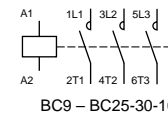
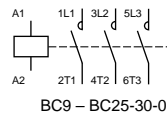

BC30-30-00

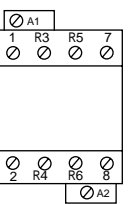

BC9 - BC25-22-00

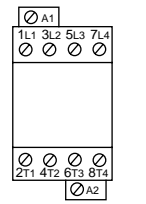

BC9 - BC25-40-00

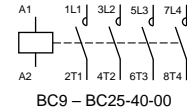
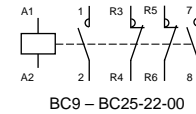
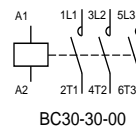

Other possible contact combinations with auxiliary contacts added by the user

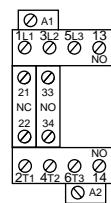

Combination 21

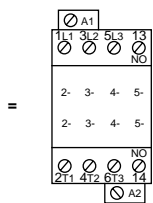

BC9 - BC25-30-10



CA5-01



CA5-10

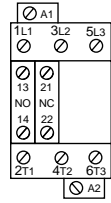

Combination 11

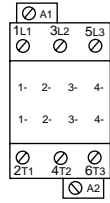

BC30-30-00



CA5-10



CA5-01

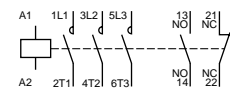
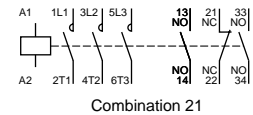

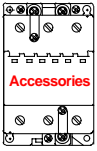

Possible accessory combinations for A contactors & N, KC control relays

Positioning	Accessories — Front face mounting		Accessories — Side mounting		
	Auxiliary contacts 1 – pole	Auxiliary contacts 4 – pole	Pneumatic timers	Auxiliary contacts	Electrical or mechanical interlock ^①
	CA5-10 or CA5-01	CA5-40 or CA5-22 or CA5-31	TP – D or TP – I	CAL 5-11	VE5-1 or VM 5-1 VE 5-2

Configurations of accessories are different depending on whether front or side mounted.

Type	Main poles	Built-in auxiliary contacts	Accessories — Front mounting		Accessories — Side mounting		
			Auxiliary contact blocks 1-pole CA5-	Auxiliary contact blocks 4-pole CA5-	TP - A Pneumatic timer block	Auxiliary contact Blocks 2-pole CAL5-11	Interlock units ● mechanical VM5- ● mech. + elec. VE5-
N	2	2 E	1 to 4 CA5- 1-pole blocks	or 1 CA5- 4-pole block	or 1 TP - A block	+ 1 to 2 CAL5-11 block	or 1 VM ^M /E5-1 block + 1 CAL5-11 block
N	3	1 E	—	—	—	—	—
N	4	0 E	—	—	—	—	—
N	4	4 E	—	—	—	—	—
N	5	3 E	—	—	—	—	—
N	6	2 E	—	—	—	—	—
N	7	1 E	—	—	—	—	—
N	8	0 E	—	—	—	—	—
A9 – A26	– 3 0 – 1 0		1 to 4 CA5- 1-pole blocks	or 1 CA5- 4-pole block	or 1 TP - A block	+ 1 to 2 CAL5-11 blocks	or 1 VM ^M /E 5-1 block + 1 CAL5-11 block
A9 – A26	– 3 0 – 0 1		—	—	—	—	—
A9 – A26	– 4 0 – 0 0		—	—	—	—	—
A9 – A26	– 2 2 – 0 0		—	—	—	—	—
A9 – A16	– 3 0 – 2 2		—	—	—	—	—
A9 – A26	– 3 0 – 3 2		—	—	—	—	—
A30, A40	– 3 0 – 1 0		1 to 5 CA5- 1-pole blocks	or 1 CA5- 4-pole block + 1 CA5- 1-pole block	or 1 TP - A block + 1 CA5- 1-pole block	+ 1 to 2 CAL5-11 blocks	or 1 VM ^M /E 5-1 block + 1 CAL5-11 block
A30, A40	– 3 0 – 0 1		—	—	—	—	—
A30, A40	– 3 0 – 3 2		1 CA5- 1-pole block	—	—	—	—
A50 – A75	– 3 0 – 0 0		1 to 6 CA5- 1-pole blocks	or 1 CA5- 4-pole block or + 2 CA5- 1-pole blocks	or 1 TP - A block + 2 CA5- 1-pole blocks	+ 1 to 2 CAL5-11 blocks	or 1 VE5-2 block + 1 CAL5-11 block
A45 – A75	– 4 0 – 0 0		—	—	—	—	—
A45, A75	– 2 2 – 0 0		—	—	—	—	—
A95, A110	– 3 0 – 0 0		—	—	—	—	—
A50 – A75	– 3 0 – 2 2		2 CA5- 1-pole blocks	—	—	—	—
A95, A110	– 3 0 – 2 2		—	—	—	—	—
AE50 – AE75	– 3 0 – 0 0		1 to 6 CA5- 1-pole blocks	or 1 CA5- 4-pole block or + 2 CA5- 1-pole blocks	or 1 TP - A block + 2 CA5- 1-pole blocks	+ 1 CAL5-11 block	or 1 VE5-2 block
AE45 – AE75	– 4 0 – 0 0		—	—	—	—	—
AE45, AE75	– 2 2 – 0 0		—	—	—	—	—
AE95, AE110	– 3 0 – 0 0		—	—	—	—	—
A50 – A75	– 3 0 – 1 1		1 to 6 CA5- 1-pole blocks	or 1 CA5- 4-pole block or + 2 CA5- 1-pole blocks	or 1 TP - A block + 2 CA5- 1-pole blocks	+ 1 CAL5-11 block + 1 CAL5-11 block	or 1 VE5-2 block or 1 VE5-2 block
AE50, AE75	– 3 0 – 1 1		—	—	—	—	—
A95, A110	– 3 0 – 1 1		—	—	—	—	—
AE95, AE110	– 3 0 – 1 1		—	—	—	—	—

Contactor mounting configurations (standard from factory)

Auxiliary contacts are mounted on the contactor in the following order:

- Left – 1st
- Right – 2nd
- Top – 3rd (L to R)

① In mounting position 5 (see page 1.20), there should be no more than 2 "N.C." front-mounted auxiliary contacts – The CAL 5-11 side-mounted blocks offer additional "N.C." contacts.

② Whatever the mounting position (see page 1.20), there should be no more than 2 "N.C." front-mounted auxiliary contacts – The CAL 5-11 side-mounted blocks offer additional "N.C." contacts.

Accessory mounting information for A & AE contactors

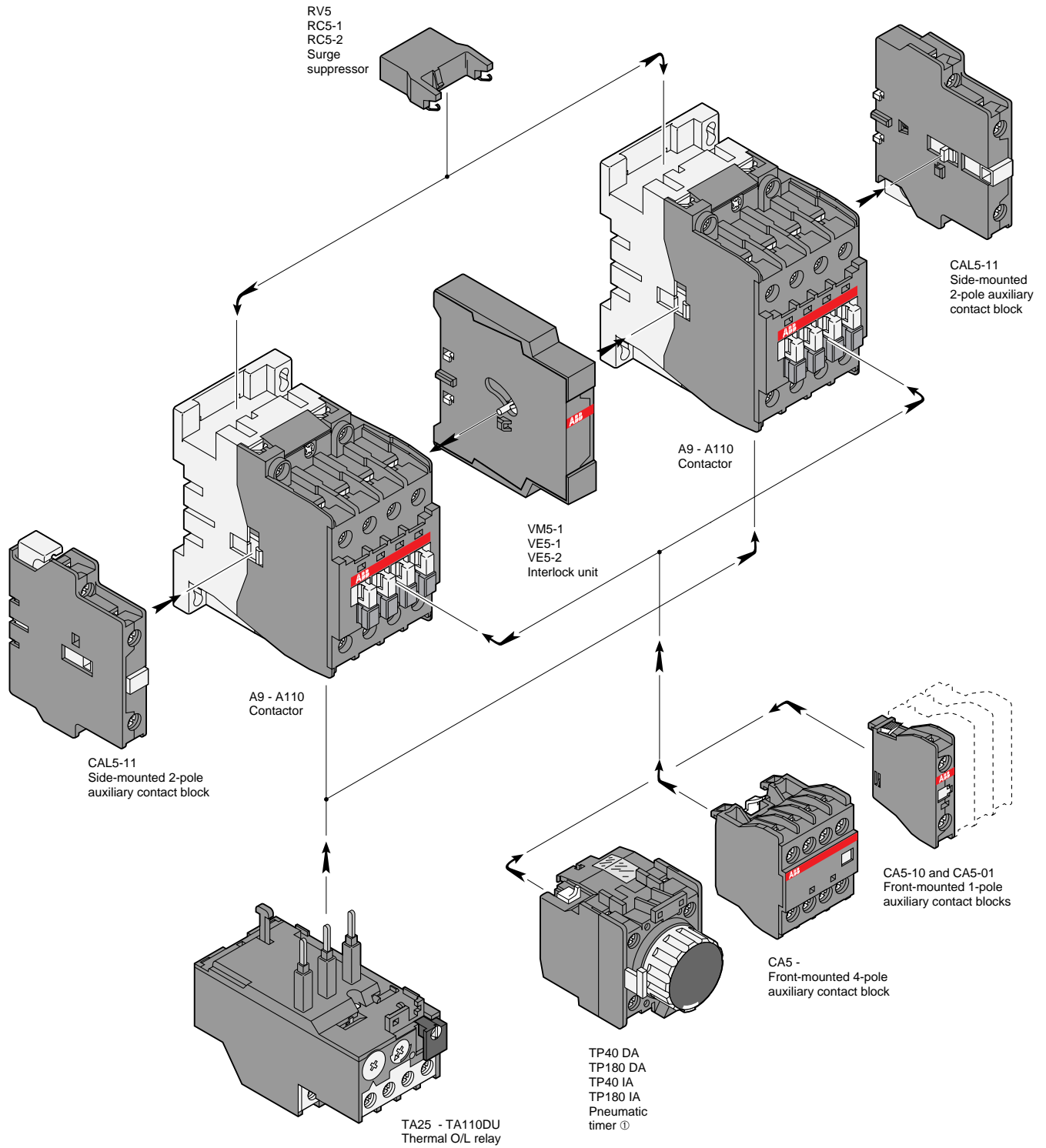
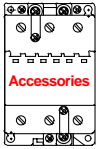

Contactors

① Not for use with A95 & A110 contactors.

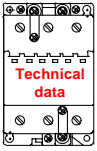

UL & CSA Technical data for AC operated A contactors Mounting positions

Contactors

ABB contactor frame size	A9	A12	A16	A26	A30	A40	A45	A50	A63	A75	A95	A110
NEMA size	00	—	0	1	1P	—	—	2	—	3	—	—
Number of poles	3 or 4	3	3 or 4	3 or 4	3	3	4	3 or 4	3	3 or 4	3	3
A.C. rating information												
NEMA cont. amp rating (thermal current)	9	—	18	27	36	—	—	45	—	90	—	—
NEMA maximum H.P. ratings (1 phase)												
115VAC	1/3	.75	1	2	3	—	—	3	—	—	—	—
230VAC	2	2	3	3	7.5	—	—	10	—	—	—	—
NEMA maximum H.P. ratings (3 phase)												
200VAC	1.5	—	3	7.5	—	—	—	10	—	25	—	—
230VAC	1.5	—	3	7.5	—	—	—	15	—	30	—	—
460/575VAC	2	—	5	10	—	—	—	25	—	50	—	—
U.L. general purpose current (40°C)	A 21	25	30	40	50	60	65	80	90	105	125	140
U.L. max 3 Ph. switching motor loads	A 9	11	17	28	32	41	—	54	65	80	95	110
U.L. maximum H.P. ratings (1 phase)												
115 VAC	1/2	3/4	1	2	3	3	—	3	5	7.5	7.5	10
230 VAC	2	2	3	5	7.5	7.5	—	7.5	10	15	20	25
U.L. maximum H.P. ratings (3 phase)												
200 - 208 VAC	2	3	5	7.5	10	10	—	15	20	25	30	30
220 - 240 VAC	2	3	5	10	10	15	—	20	25	30	30	40
440 - 480 VAC	5	7.5	10	20	20	30	—	40	50	60	60	75
550 - 600 VAC	7.5	10	15	25	30	40	—	50	60	75	75	100
Lighting-ballast and incand., 600 VAC	15	15	20	35	50	60	65	65	85	105	—	—
Resistive heating applications, 600 VAC	15	15	20	35	50	60	65	65	85	105	—	—
Auxiliary contacts												
NEMA rating, AC												
AC rated voltage, VAC	A600	A600	A600	A600	A600	A600	—	A600	A600	A600	A600	A600
AC thermal rated current, A	600	600	600	600	600	600	—	600	600	600	600	600
AC maximum volt-ampere making, VA	10	10	10	10	10	10	—	10	10	10	10	10
AC maximum volt-ampere breaking, VA	7200	7200	7200	7200	7200	7200	—	7200	7200	7200	7200	7200
NEMA rating, DC												
DC rated voltage, VDC	P600	P600	P600	P300	P300	P300	—	P300	P300	P300	P300	P300
DC thermal rated current, A	600	600	600	600	600	600	—	600	600	600	600	600
DC maximum make-break	5	5	5	5	5	5	—	5	5	5	5	5
	A 0.2	0.2	0.2	0.2	0.2	0.2	—	0.2	0.2	0.2	0.2	0.2
Approximate weight												
Contactors	Lbs.	0.7	0.7	0.7	1.01	1.2	2.25	2.25	2.25	2.25	3.5	5
Starters	Lbs.	1.04	1.04	1.04	1.35	1.54	3	—	3	3	6	7
Wire range												
Number of wires per phase	AWG	18 - 10	18 - 10	18 - 10	12 - 8	8 - 4	8 - 4	8 - 1	8 - 1	8 - 1	8 - 1	6 - 2/0
Tightening torque, lb. in.		2	2	2	2	2	2	1	1	1	1	1
		9	9	9	15	20	20	40	40	40	50	50

Mounting positions

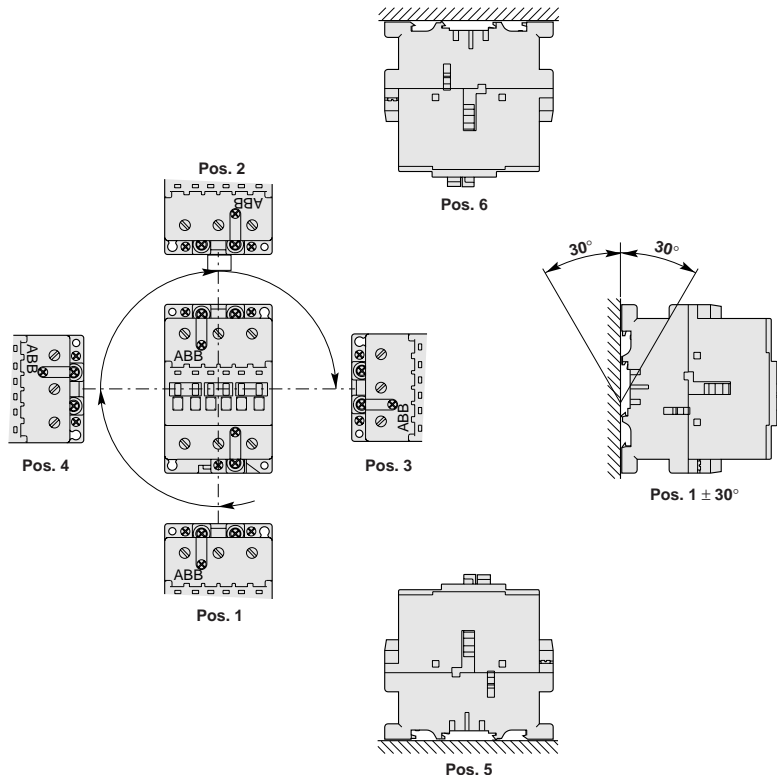

IEC Technical data for AC operated A contactors

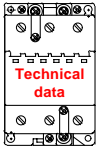

Type	A9	A12	A16	A26	A30	A40	A45	A50	A63	A75	A95	A110		
Number of poles	3 or 4	3	3 or 4	3 or 4	3	3	4	3 or 4	3	3 or 4	3	3		
Insulation characteristics														
Rated insulation voltage U_i acc. to IEC947-4-1 and VDE0110 (Gr. C) according to UL/CSA	V							1000						
	V							600						
Rated impulse withstand voltage U_{imp}							8 kV							
Main pole utilization characteristics														
Rated operational voltage U_e	V	690			690			1000			1000			
Conventional free-air thermal current I_{th} acc. to IEC947-4-1, open contactors $\theta \leq 40^\circ\text{C}$	A	26	28	30	45	65	65	100	100	125	125	145	160	
	with conductor cross-sectional area mm ²	4	4	4	6	16	16	35	35	50	50	50	70	
Rated operational current $I_e/AC-1$ for air temperature close to contactor	$\left\{ \begin{array}{l} \theta \leq 40^\circ\text{C} \\ \theta \leq 55^\circ\text{C} \\ \theta \leq 70^\circ\text{C} \end{array} \right.$	A	25	27	30	45	55	60	70	100	115	125	145	160
		A	22	25	27	40	55	60	60	85	95	105	135	145
		A	18	20	21	32	39	42	50	70	80	85	115	130
		with conductor cross sectional area mm ²	2.5	4	4	6	10	16	25	35	50	50	50	70
Utilization category AC-3 for air temperature close to contactor $\leq 55^\circ\text{C}$														
Rated operational current $I_e/AC-3 (1)$ 3-phase Motors	220-230-240 V	A	9	12	17	26	33	40	40	53	65	75	96	110
	380-400 V	A	9	12	17	26	32	37	37	50	65	75	96	110
	415 V	A	9	12	17	26	32	37	37	50	65	72	96	110
	440 V	A	9	12	16	26	32	37	37	45	65	70	93	100
	500 V	A	9	12	14	22	28	33	33	45	55	65	80	100
	690 V	A	7	9	10	17	21	25	25	35	43	46	65	82
	1000 V	A	—	—	—	—	—	—	—	23	25	28	30	30
	Rated operational power AC-3 (1) 1500 r.p.m. - 50 Hz 1800 r.p.m. - 60 Hz 3-phase Motors	220-230-240 V	kW	2.2	3	4	6.5	9	11	11	15	18.5	22	25
380-400 V	kW	4	5.5	7.5	11	15	18.5	18.5	22	30	37	45	55	
415 V	kW	4	5.5	9	11	15	18.5	18.5	25	37	40	55	59	
440 V	kW	4	5.5	9	15	18.5	22	22	25	37	40	55	59	
500 V	kW	5.5	7.5	9	15	18.5	22	22	30	37	45	55	59	
690 V	kW	5.5	7.5	9	15	18.5	22	22	30	37	40	55	75	
1000 V	kW	—	—	—	—	—	—	—	30	33	37	40	40	
Rated frequency limits	Hz	25 – 400												
Mechanical durability in millions of operating cycles		10										10		
Max. mechanical switching frequency	cycles/h	3600												
Max. electrical switching frequency	for AC-1	cycles/h	600	600	600	600	600	600	600	600	600	600	300	300
	for AC-3	cycles/h	1200	1200	1200	1200	1200	1200	600	600	600	600	300	300
	for AC-2, AC-4	cycles/h	300	300	300	300	300	300	150	150	150	150	150	150
Electrical durability														
Rated making capacity AC-3 according to IEC947-4-1	see pages 1.27 – 1.30													
Rated breaking capacity AC-3 according to IEC947-4-1	10 x I_e AC-3										12 x I_e AC-3			
Max. breaking capacity $\cos \varphi = 0.45$ ($\cos \varphi = 0.35$ for $I_e > 100$ A)	at 440 V	A	250	250	250	420	820	820	900	900	900	900	1160	1160
	at 690 V	A	100	100	100	170	340	340	490	490	490	490	800	800
Short-circuit protection for contactors without thermal O/L relays - Motor protection excluded^① $U_e \leq 500$ V a.c. – gG (gl) type fuses														
Rated short-time withstand current I_{cw} at 40°C ambient temp., in free air, from a cold state	1 s	A	250	280	300	400	600	600	1000	1000	1000	1000	1320	1320
	10 s	A	100	120	140	210	400	400	650	650	650	650	800	800
	30 s	A	60	70	80	110	225	225	370	370	370	370	500	500
	1 min	A	50	55	60	90	150	150	250	250	250	250	350	350
	15 min	A	26	28	30	45	65	65	100	100	100	100	160	175
Heat dissipation per pole	$I_e/AC-1$	W	0.8	1	1.2	1.8	2.5	3	2.5	5	6.5	7	6.5	7.5
	$I_e/AC-3$	W	0.1	0.2	0.35	0.6	0.9	1.3	0.65	1.3	1.5	2	2.7	3.6



Contactors

^① Please consult us for the protection of motor starters against short circuits.

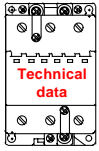

IEC Technical data for AC operated A contactors

Type	A9	A12	A16	A26	A30	A40	A45	A50	A63	A75	A95	A110
Number of poles	3 or 4	3	3 or 4	3 or 4	3	3	4	3 or 4	3	3 or 4	3	3

General technical data

Standards	Devices complying with international standards IEC947-1 / 947-4-1 and European standards EN60 947-1 / 60 947-4-1 Electromagnetic compatibility (EMC) according to amendment A11 to IEC947-1; EN60 947-1 and amendment 2 to IEC947-4-1
------------------	--

Certifications – approvals	See page V
-----------------------------------	------------

Air temperature close to contactor			
— fitted with thermal O/L relay	°C	— 25 to + 55 (0.85 – 1.1 U _e)	— 25 to +55 (0.85 – 1.1U _e)
— without thermal O/L relay	°C	— 40 to + 55 (0.85 – 1.1 U _e) / – 40 to + 70 (U _e)	— 25 to +70 (0.85 – 1.1U _e)
— for storage	°C	— 60 to + 80	— 40 to +70

Climatic withstand	acc. to IEC 68-2-30 and 68-2-11 – UTE C 63-100 specification II	acc. to IEC 68-2-30
---------------------------	---	---------------------

Mounting positions: (see diagram, page 1.20)	Positions 1 to 5	— Ambient temperature ≤ 55°C and control voltage 0.85 – 1.1 U _e — Ambient temperature 55 – 70°C and control voltage equal to U _e
	Position 6	— Ambient temperature ≤ 55°C and control voltage 0.95 – 1.1 U _e — Ambient temperature > 55°C unauthorized

Operating altitude	m	≤ 3000
---------------------------	---	--------

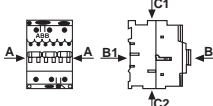
Shock withstand acc. to IEC68-2-27 and EN60068-2-27 Mounting position 1 (See page 1.20)		1/2 sinusoidal shock for 11ms: no change in contact position Shock direction: A, C1, C2 : 20 g B1 : 5 g B2 : 15 g
		Note: only on plate for A95 and A110

Mounting	• on mounting rail	acc. to IEC715 and EN50 022 35 x 7.5 mm 35 x 15 mm	acc. to IEC715 35 x 15 EN50 022 75 x 25 EN50 023	acc. to IEC715 and EN50 023 75 x 25
	• by screws (not supplied)	2 x M4	2 x M6	

Connecting terminals (delivered in open position)	— Main poles	(+,-) pozidriv 2screw			M 8 slotted screw head with single connector 13 x 10 mm	HC, M 8 hexagon socket screw with single connector 14 x 14 mm
		M 3.5 with cable clamp	M 4 with clamp	M 5 with 2x(5.6x6.5mm) double connect.		
	— Coil terminals	M 3.5 (+,-) pozidriv 2 screws with cable clamp				
	— Built in aux. terminals	(+,-) pozidriv 2 screw and cable clamp				
		M 3.5	M 4	M 3.5		

Connecting capacity						
Main conductors (poles)	Rigid solid (≤4 mm ²) / rigid stranded (≥6 mm ²)	1 x mm ²	min. – max.	min.– max.	min. – max.	min. – max.
		2 x mm ²	1 – 4 1 – 4	1.5 – 6 1.5 – 6	2.5 – 16 2.5 – 16	6 – 50 6 – 25
	Flexible without cable end	1 x mm ²	0.75 – 2.5	1 – 4	2.5 – 10	6 – 35
		2 x mm ²	0.75 – 2.5	1 – 4	2.5 – 10	6 – 16
	Bars or lugs:	max. width	8	10	—	30
		hole Ø	3.7	4.2	—	6
		mm ≤				
		mm >				
Auxiliary conductors (built in aux. terminals + coil terminals)			min. - max.			
Rigid solid	1 or 2 x mm ²		1 - 4			0.75 – 2.5
Flexible without cable end	1 x mm ²	0.75 – 2.5	⊙	0.75 – 2.5	1 – 2.5	0.75 – 2.5
	2 x mm ²	0.75 – 2.5	⊙	0.75 – 2.5	0.75 – 2.5	0.75 – 2.5

Degree of protection acc. to IEC529, IEC947-1 and EN60529	— Main terminals	Protection against direct contact acc. to VDE0106 — Part. 100	
	— Coil terminals	IP20	IP10
	— Auxiliary terminals		IP20 IP20

⊙ 1 or 2 times 0.75 – 2.5mm² but with 0.75 and 1 mm² cable end.

IEC Technical data for AC operated A contactors

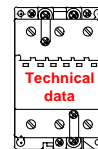

Magnet system characteristics

Type	A9	A12	A16	A26	A30	A40	A45	A50	A63	A75	A95	A110
Number of poles	3 or 4	3	3 or 4	3 or 4	3	3	4	3 or 4	3	3 or 4	3	3
Coil operating limits acc. to IEC947-4-1: $0.85 - 1.1 \times U_c$	$\theta \leq 55^\circ\text{C}$										$\theta \leq 70^\circ\text{C}$	
Drop out voltage in % of U_c	roughly 40 – 65 %											
Coil consumption												
Average pull in value	— 50 Hz — 60 Hz	VA VA	70 80		120 140			180 210				350 450
Average holding value	— 50/60 Hz ^① — 50 Hz — 60 Hz — 50/60 Hz ^①	VA/VA VA/W VA/W VA/W	74/70 8/2 8/2 8/2		125/120 12/3 12/3 12/3			190/180 18/5.5 18/5.5 18/5.5				410 / 365 22 / 6.5 26 / 8 27 / 7.5
Rated control circuit voltage U_c												
	at 50 Hz at 60 Hz	V V						20 – 690 24 – 600				
Operating time												
	Between coil energization and: — N.O. contact closing — N.C. contact opening	ms ms	10 – 26 7 – 21		8 – 21 6 – 18			8 – 27 7 – 22				10 – 25 7 – 22
	Between coil deenergization and: — N.O. contact opening — N.C. contact closing	ms ms	4 – 11 9 – 16		4 – 11 7 – 14			4 – 11 7 – 14				7 – 15 10 – 18

Characteristics of A9 – A40 contactor built in auxiliary contacts (for additional auxiliary contact blocks: see page 1.17)

Rated operational voltage U_e	V	690		
Conventional free air thermal current $I_{th} - \theta \leq 40^\circ\text{C}$	16			
Rated operational current	24 – 127 V 220 – 240 V 380 – 440 V 500 V 690 V	50/60 Hz 50/60 Hz 50/60 Hz 50/60 Hz 50/60 Hz	A A A A A	6 4 3 2 2
I_e / AC-15 acc. to IEC947-5-1				
I_e / DC-13 acc. to IEC947-5-1	24 V 48 V 72 V 125 V 250 V	d.c. d.c. d.c. d.c. d.c.	A/W A/W A/W A/W A/W	6 / 144 2.8 / 134 2 / 144 1.1 / 138 0.55 / 138
Operational current frequency	Hz	25 – 400		
Rated making capacity	acc. to IEC 947-5-1	10 x I_e / AC-15		
Rated breaking capacity	acc. to IEC 947-5-1	10 x I_e / AC-15		
Short circuit protection – gG (gl) type fuses	A	10		
Rated short time withstand current I_{ew}	for 1.0 s for 0.1 s	100A 140A		
Insulating resistance at 500 V d.c.		after durability test: 5M Ω		
Min. switching capacity		17V/ 5 mA		
Non overlapping time between N.O. and N.C. contacts	ms	≥ 2		
Heat dissipation per pole at 6 A	W	0.10		
Electrical durability				
Max. switching frequency	1200 cycles/h			
AC-15 according to IEC947-5-1	making current: $10 \times I_e$ with $\cos \varphi = 0.7$ and U_e breaking current: I_e with $\cos \varphi = 0.4$ and U_e			
The curve opposite shows the electrical durability of the built in auxiliary contacts with respect to the breaking current.				
This curve has been drawn for resistive and inductive loads up to 690 V, 40 - 60 Hz.				

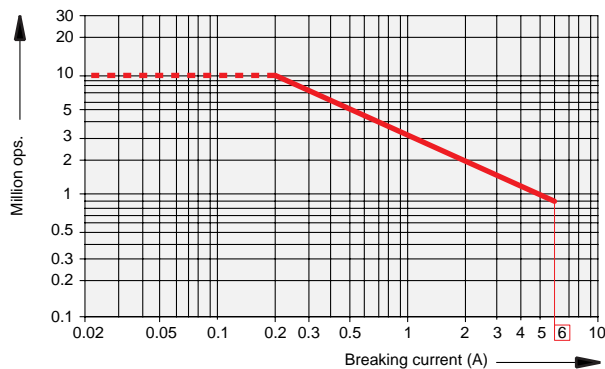

AC 1030 – 6/98

① 50/60 Hz coils: voltage codes 80 to 88, see page 1.13.

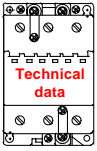

IEC Technical data for DC operated A contactors

Contactors

Type		BC9	BC16	BC25	BC30	AE45	AE50	AE63	AE75	AE95	AE110			
Number of poles		3 or 4	3 or 4	3 or 4	3	4	3 or 4	3	3 or 4	3	3			
Insulation characteristics														
Rated insulation voltage U_i according to IEC947-4-1 and VDE0110 (Gr. C) according to UL/CSA	V	690			1000		1000			1000				
	V	600			600		600			600				
Rated impulse withstand voltage U_{imp}		6 kV				8 kV				8 kV				
Main pole utilization characteristics														
Rated operational voltage U_e	V	690			690		1000			1000				
Conventional free air thermal current I_{th} acc. to IEC947-4-1, open contactors with conductor cross sectional area	$\theta \leq 40^\circ\text{C}$	A	26	28	45	65	100	100	125	125	145	160		
		mm ²	4	4	6	10	35	35	50	50	50	70		
Rated operational current $I_e/AC-1$ for air temperature close to contactor	with conductor cross sectional area	mm ²	$\theta \leq 40^\circ\text{C}$	A	22	28	45	55	70	100	115	125	145	160
			$\theta \leq 55^\circ\text{C}$	A	20	25	40	45	60	85	95	105	135	145
			$\theta \leq 70^\circ\text{C}$	A	17	23	32	36	50	70	80	85	115	130
				mm ²	2.5	4	6	6	25	35	50	50	50	70
Utilization category AC-3 for air temperature close to contactor $\leq 55^\circ\text{C}$														
Rated operational current $I_e/AC-3 (1)$ 3 phase motors	220 – 230 – 240 V 380 – 400 V 415 V 440 V 500 V 690 V 1000 V	A		9	16	25	33 ^①	40	53	65	75	96	110	
				9	16	25	30	37	50	65	75	96	110	
				9	16	25	30	37	50	65	72	96	110	
				9	16	20	27	37	45	65	70	93	100	
				7	13	17	23	33	45	55	65	80	100	
				6	8	13	18	25	35	43	46	65	82	
				—	—	—	—	—	23	25	28	30	30	
				—	—	—	—	—	—	—	—	—	—	
Rated operational power AC-3 (1) 1500 r.p.m. – 50 Hz or 1800 r.p.m. – 60 Hz 3 phase motors	220 – 230 – 240 V 380-400 V 415 V 440 V 500 V 690 V 1000 V	kW		2.2	4	6.5 ^②	9	11	15	18.5	22	25	30	
				4	7.5	11	15	18.5	22	30	37	45	55	
				4	7.5	11	15	18.5	25	37	40	55	59	
				4	7.5	11	15	22	25	37	40	55	59	
				4	7.5	11	15	22	30	37	45	55	59	
				4	5.5	11	15	22	30	37	40	55	75	
				—	—	—	—	—	30	33	37	40	40	
				—	—	—	—	—	—	—	—	—	—	
Rated frequency limits Hz 25 – 400														
Mechanical durability in millions of operating cycles														
Max. mechanical switching frequency			6000	3000	3600	3600	3600	3600	3600	3600	3600	3600		
Max. electrical switching frequency		for AC-1	600	600	600	300	300	300	300	300	300	300		
		for AC-3	1200	600	600	300	300	300	300	300	300	300		
		for AC-2, AC-4	300	150	150	150	150	150	150	150	150	150		
Electrical durability see page 1.27 – 1.30														
Rated making capacity AC-3 according to IEC947-4-1			10 x $I_e / AC-3$						12 x $I_e / AC-3$					
Rated breaking capacity AC-3 according to IEC947-4-1			8 x $I_e / AC-3$						8 x $I_e / AC-3$					
Max. breaking capacity with $\cos j = 0.45$ ($\cos j = 0.35$ for $I_e > 100$ A)		at 440V	200	315	380	900	900	900	900	900	1160	1160		
		at 690V	120	210	290	490	490	490	490	490	800	800		
Short-circuit protection for contactors without thermal O/L relay – Motor protection excluded ^③ $U_e \leq 500$ V a.c. – gG (gl) type fuses														
Rated short-time withstand current I_{sw}		A	25	32/35	50	63	80	100	125	160	160	200		
at 40°C ambient temperature, in free air, from cold state		1 s	A	200	280	350	400	1000	1000	1000	1000	1320	1320	
		10 s	A	90	130	200	250	650	650	650	650	800	800	
		30 s	A	50	70	110	150	370	370	370	370	500	500	
		1 min	A	40	50	90	120	250	250	250	250	350	350	
		15 min	A	22	28	45	55	100	100	115	125	160	175	
Heat dissipation per pole		$I_e/AC-1$	W	0.55	1.5	2.4	2.2	2.5	5	6.5	7	6.5	7.5	
		$I_e/AC-3$	W	0.10	0.4	0.6	0.6	0.65	1.3	1.5	2	2.7	3.6	



① 32 A at 240V
 ② 7.5 kW at 240V
 ③ For the protection of motor starters against short circuits, please consult us.

IEC Technical data for DC operated A contactors

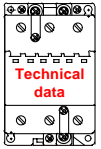

Type	BC9	BC16	BC25	BC30	AE45	AE50	AE63	AE75	AE95	AE110
Number of poles	3 or 4	3 or 4	3 or 4	3	4	3 or 4	3	3 or 4	3	3
General technical data										
Standards	Devices complying with international standards IEC947-1 / 947-4-1 and European standards EN60 947-1 / 60 947-4-1 Electromagnetic compatibility (EMC) according to amendment A11 to IEC947-1; EN60 947-1 and amendment 2 to IEC947-4-1									
Certifications – approvals	See pg V									
Air temperature	close to contactor	°C		-25 to +50 (0.85 to 1.1 U _e)			-25 to +50 (0.85 to 1.1 U _e)		-25 to +55 (0.85 to 1.1U _e)	
	– with a thermal O/L relay mounted	°C		-40 to +55 (0.85 to 1.1 U _e) / +55 to +70 (U _e)			-40 to +55 (0.85 to 1.1 U _e) / +55 to +70 (U _e)		-25 to +70 (0.85 to 1.1U _e)	
	– without thermal O/L relay mounted	°C		-60 to +80			-60 to +80		-40 to +70	
	– for storage									
Climatic withstand	according to IEC 68-2-30 and 68-2-11 – UTE C 63-100 specification II									
Mounting positions: (see drawing page 1.20)	Positions 1,3, 4	-θ ≤ 55 °C: 0.85 to 1.1 U _e -θ = 55 to 70 °C: — U _e			Positions 1 to 5			-θ ≤ 55 °C: 0.85 to 1.1 U _e -θ = 55 to 70 °C: — U _e		
	Positions 2,6	-θ ≤ 55 °C: 0.95 to 1.1 U _e -θ > 55 °C: not acceptable			Position 6			-θ ≤ 55 °C: 0.95 to 1.1 U _e -θ > 55 °C: not acceptable		
	Position 5:	see tables p. 1.19								
Operating altitude	m	≤ 3000								
Shock withstand acc. to IEC68-2-27 and EN60068-2-27 Mounting position 1 (See page 1.20)	1/2 sinusoidal shock for 11ms: no change in contact position									
	Shock direction: A, C1, C2: 20 g B1 : 5 g B2 : 15 g									
	Note: only on plate for A95 and A110									
Mounting	• on mounting rail	according to IEC715 and EN50 022 35 x 7.5 mm 35 x 15 mm			according to IEC715 35 x 15 EN50 022 75 x 25 EN50 023			acc. to IEC715 and EN 50 023 75 x 25		
	• by screws (not supplied)	2 x M 4			2 x M 6					
Connecting terminals (delivered in open position)	– Main poles	(+, -) pozidriv 2 screw with cable clamp			M8 slotted screw head with single connector 13 x 10 mm			HC, M8, hexagon socket screw with single connector 14 x 14 mm		
	– Coil terminals	M 3.5 (+, -) pozidriv 2 screw with cable clamp								
	– Built in aux. terminals	(+, -) pozidriv 2 screw with cable clamp								
		M 3.5			M 4					
Connecting capacity		min. – max.			min. – max.			min. – max.		
Main conductors (poles)		min. – max.			min. – max.			min. – max.		
Rigid solid (≤ 4 mm ²) / rigid stranded (≥ 6 mm ²)	1 x mm ² 2 x mm ²	1 – 4 1 – 4	1.5 – 6 1.5 – 6	2.5 – 10 2.5 – 10	6 – 50 6 – 25			6 – 95 6 – 35		
Flexible without cable end	1 x mm ² 2 x mm ²	1 – 2.5 0.75 – 2.5	1.5 – 4 1.5 – 4	2.5 – 6 2.5 – 6	6 – 35 6 – 16			6 – 70 6 – 35		
Bars or lugs:	max. width hole Ø	mm ≤ mm >	8 3.7	10 4	13 5			— 30 — 6		
Auxiliary conductors (built in auxiliary terminals + coil terminals)		min. – max.			min. – max.			min. – max.		
Rigid solid	1 or 2 x mm ²	1 – 4			0.75 – 2.5			min. – max. 0.75 – 2.5		
Flexible without cable end ^①	1 x mm ² 2 x mm ²	1 – 2.5 0.75 – 2.5			min. – max. 0.75 – 2.5			min. – max. 0.75 – 2.5		
Degree of protection acc. to IEC529, IEC947-1 and EN60529	Protection against direct contact according to VDE 0106 – Part. 100									
– Main terminals	IP10			IP10			IP10			IP10
– Coil terminals	IP20			IP20			IP20			IP20
– Auxiliary terminals	IP10			IP10			IP10			IP20

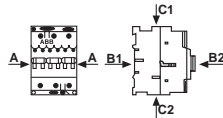

① Except auxiliary built into BC 25: 0.75 – 4 mm²

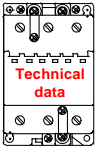

IEC Technical data for DC operated A contactors

Magnet system characteristics

Type		BC9	BC16	BC25	BC30	AE45	AE50	AE63	AE75	AE95	AE110			
Number of poles		3 or 4	3 or 4	3 or 4	3	4	3 or 4	3	3 or 4	3	3			
Coil operating limits acc. to IEC947-4-1: 0.85 to $1.1 \times U_c$		$\theta \leq 55^\circ\text{C}$								$\theta \leq 70^\circ\text{C}$				
Drop out voltage % of U_c		roughly 15 – 40 %												
Coil consumption (average value)	— pull in, from cold state	W				200				400				
	— holding, from warm state	W				4				2.4				
Rated control circuit voltage U_c	V	6 – 250				12 – 250				12 – 250				
Operating time	Between coil energization and:	— N.O. contact closing	ms				50 – 75				13 – 30		15 – 25	
		— N.C. contact opening	ms				45 – 70				10 – 27		12 – 22	
	Between coil de-energization and:	— N.O. contact opening	ms				15 – 30*				5 – 15*		15 – 20*	
		— N.C. contact closing	ms				17 – 32*				8 – 18*		18 – 23*	
*The use of surge suppressors increases the opening time on a scale of 1.1 to 1.5 for a varistor suppressor and on a scale of 4 to 8 for a diode suppressor.														

Characteristics of BC9 – BC25 contactor built in auxiliary contacts

Rated operational voltage U_e	V			690	
Conventional free air thermal current I_{th}	A			10	
Rated operational current I_e /AC-15 acc. to IEC947-5-1	24 – 127 V	50/60 Hz	A	6	
	220 – 240 V	50/60 Hz	A	4	
	380 – 440 V	50/60 Hz	A	3	
	500 V	50/60 Hz	A	2	
	690 V	50/60 Hz	A	2	
I_e /DC-13 acc. to IEC947-5-1	24 V	d.c.	A/W	6 / 144	
	48 V	d.c.	A/W	2.8 / 134	
	72 V	d.c.	A/W	2 / 144	
	125 V	d.c.	A/W	1.1 / 138	
	250 V	d.c.	A/W	0.55 / 138	
Operational current frequency	Hz			25 – 400	
Rated making capacity		acc. to IEC947-5-1		$10 \times I_e$ /AC – 15	
Rated breaking capacity		acc. to IEC947-5-1		$10 \times I_e$ /AC – 15	
Short circuit protection – gG (gl) type fuses	A			10	
Rated short time withstand current I_{cw}		for 1.0 s		50 A	
		for 0.1 s		100 A	
Insulation resistance at 500 V d.c.				after durability test: 5 M Ω	
Min. switching capacity				24V / 5 mA	
Non overlapping time between N.O. and N.C. contacts	ms			≥ 2	
Heat dissipation per pole at 6 A	W			0.15	

Electrical durability
Max. switching frequency 1200 cycles/h
 AC-15 according to IEC947-5-1
 making current: $10 \times I_e$ with $\cos \varphi = 0.7$ and U_e
 breaking current: I_e with $\cos \varphi = 0.4$ and U_e

The curve opposite shows the electrical durability of the built in auxiliary contacts with respect to the breaking current.

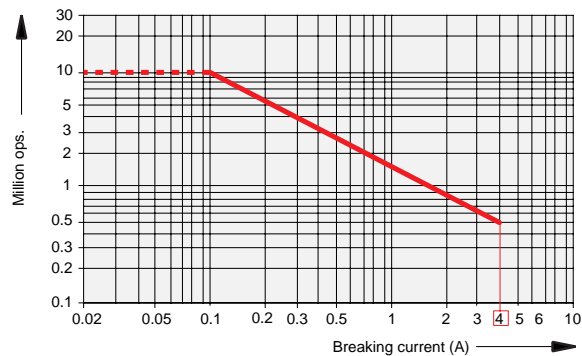

This curve has been drawn for resistive and inductive loads up to 690 V, 40 – 60 Hz.

Motor data

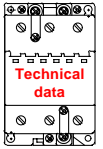

Ampere ratings of 3 phase, AC induction motors^①

Horse power	110 – 120V			220 – 240V			380 – 415V ^②		440 – 480V			550 – 600V		
	Single phase	Two phase	Three phase	Single phase	Two phase	Three phase	Single phase	Three phase	Single phase	Two phase	Three phase	Single phase	Two phase	Three phase
1/10	3.0	—	—	1.5	—	—	1.0	—	—	—	—	—	—	—
1/8	3.8	—	—	1.9	—	—	1.2	—	—	—	—	—	—	—
1/6	4.4	—	—	2.2	—	—	1.4	—	—	—	—	—	—	—
1/4	5.8	—	—	2.9	—	—	1.8	—	—	—	—	—	—	—
1/3	7.2	—	—	3.6	—	—	2.3	—	—	—	—	—	—	—
1/2	9.8	4.0	4.4	4.9	2.0	2.2	3.2	1.3	2.5	1.0	1.1	2.0	0.8	0.9
3/4	13.8	4.8	6.4	6.9	2.4	3.2	4.5	1.8	3.5	1.2	1.6	2.8	1.0	1.3
1	16.0	6.4	8.4	8.0	3.2	4.2	5.1	2.3	4.0	1.6	2.1	3.2	1.3	1.7
1 1/2	20.0	9.0	12.0	10.0	4.5	6.0	6.4	3.3	5.0	2.3	3.0	4.0	1.8	2.4
2	24.0	11.8	13.6	12.0	5.9	6.8	7.7	4.3	6.0	3.0	3.4	4.8	2.4	2.7
3	34.0	16.6	19.2	17.0	8.3	9.6	10.9	6.1	8.5	4.2	4.8	6.8	3.3	3.9
5	56.0	26.4	30.4	28.0	13.2	15.2	17.9	9.7	14.0	6.6	7.6	11.2	5.3	6.1
7 1/2	80.0	38.0	44.0	40.0	19.0	22.0	27.0	14.0	21.0	9.0	11.0	16.0	8.0	9.0
10	100.0	48.0	56.0	50.0	24.0	28.0	33.0	18.0	26.0	12.0	14.0	20.0	10.0	11.0
15	135.0	72.0	84.0	68.0	36.0	42.0	44.0	27.0	34.0	18.0	21.0	27.0	14.0	17.0
20	—	94.0	108.0	88.0	47.0	54.0	56.0	34.0	44.0	23.0	27.0	35.0	19.0	22.0
25	—	118.0	136.0	110.0	59.0	68.0	70.0	44.0	55.0	29.0	34.0	44.0	24.0	27.0
30	—	138.0	160.0	136.0	69.0	80.0	87.0	51.0	68.0	35.0	40.0	54.0	28.0	32.0
40	—	180.0	208.0	176.0	90.0	104.0	112.0	66.0	88.0	45.0	52.0	70.0	36.0	41.0
50	—	226.0	260.0	216.0	113.0	130.0	139.0	83.0	108.0	56.0	65.0	86.0	45.0	52.0
60	—	—	—	—	133.0	154.0	—	103.0	—	67.0	77.0	—	53.0	62.0
75	—	—	—	—	166.0	192.0	—	128.0	—	83.0	96.0	—	66.0	77.0
100	—	—	—	—	218.0	248.0	—	165.0	—	109.0	124.0	—	87.0	99.0
125	—	—	—	—	—	312.0	—	208.0	—	135.0	156.0	—	108.0	125.0
150	—	—	—	—	—	360.0	—	240.0	—	156.0	180.0	—	125.0	144.0
200	—	—	—	—	—	480.0	—	320.0	—	208.0	240.0	—	167.0	192.0
250	—	—	—	—	—	602.0	—	403.0	—	—	302.0	—	—	242.0
300	—	—	—	—	—	—	—	482.0	—	—	361.0	—	—	289.0
350	—	—	—	—	—	—	—	560.0	—	—	414.0	—	—	336.0
400	—	—	—	—	—	—	—	636.0	—	—	477.0	—	—	382.0
500	—	—	—	—	—	—	—	786.0	—	—	590.0	—	—	472.0

Contactors

AC 1030 – 6/98

^① To obtain full load currents for 200V and 208V motors, increase corresponding 220 – 240V ratings by 15 percent and 10 percent.
^② To obtain full load currents for 265V and 277V motors, decrease corresponding 220 – 240V ratings by 13 percent and 17 percent.

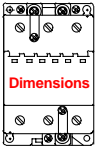

Approximate dimensions for 3 pole, AC operated A contactors & starters A9 – A16

← 00.00 → Inches
00.00 → Millimeters

A9 – A16 — Contactor, 3 pole, AC operated

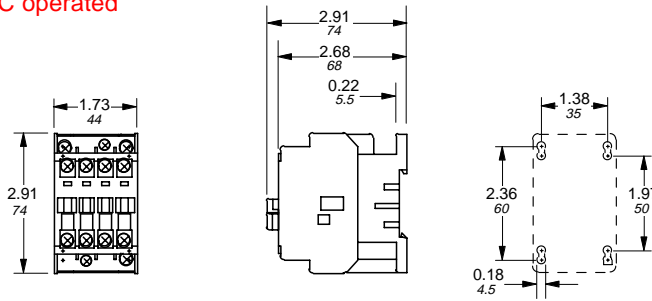

A9 – A16 + VM5 or VE5 — Mechanically interlocked contactor, 3 pole, AC operated

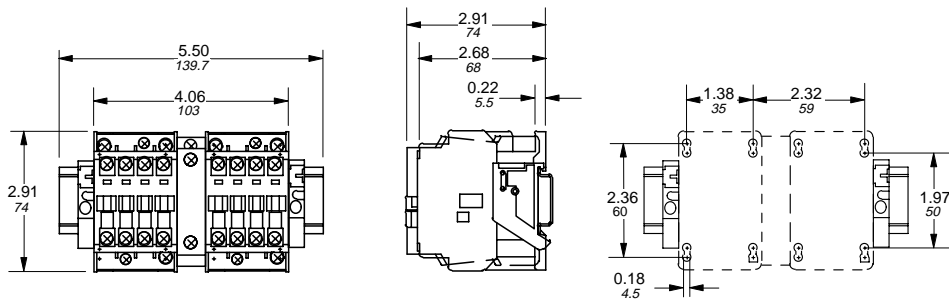

A9 – A16 + TA25 — Starter, 3 pole, AC operated

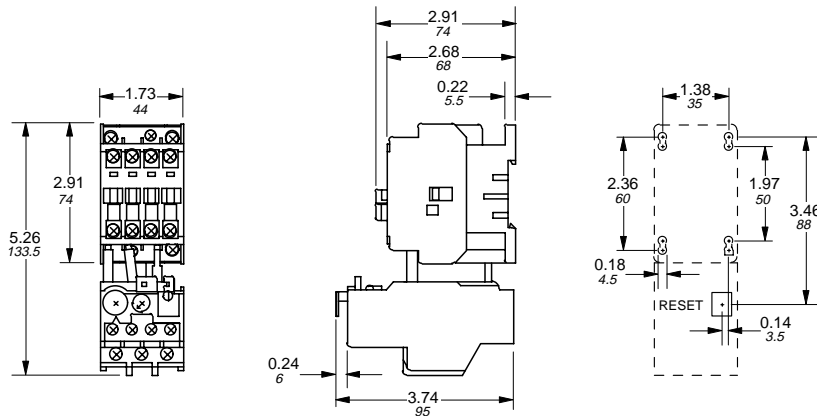

A9 – 16 + VM5 or VE5 + TA25 — Reversing starter, 3 pole, AC operated

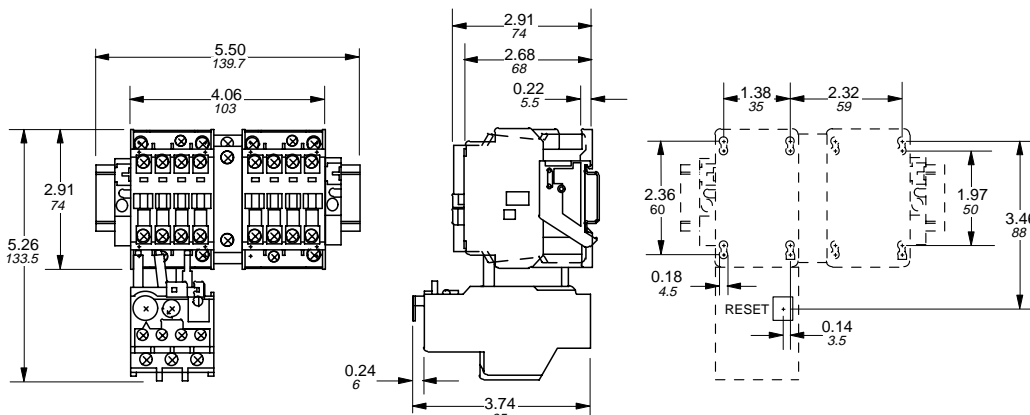

Approximate dimensions for 3 pole, AC operated A contactors & starters A26

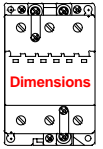

00.00 Inches
00.00 Millimeters

A26 — Contactor, 3 pole, AC operated

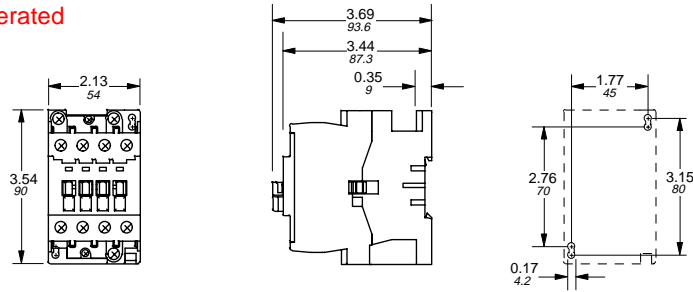

A26 + VM5 or VE5 — Mechanically interlocked contactor, 3 pole, AC operated

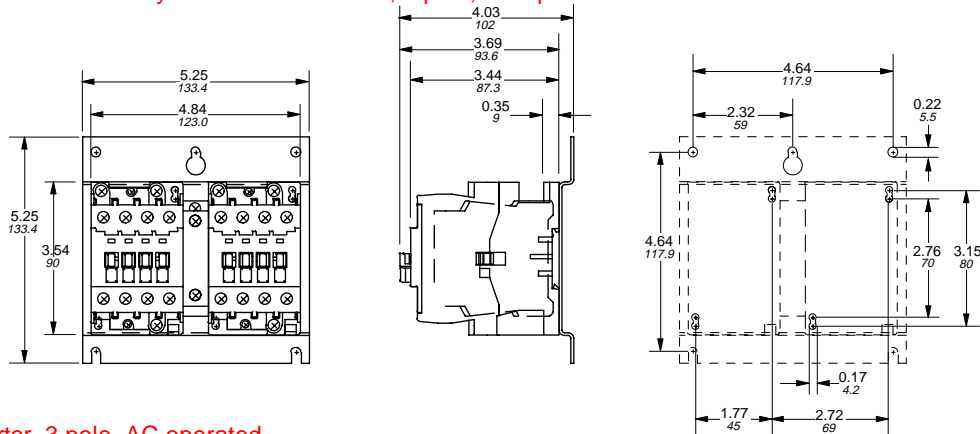

A26 + TA25 — Starter, 3 pole, AC operated

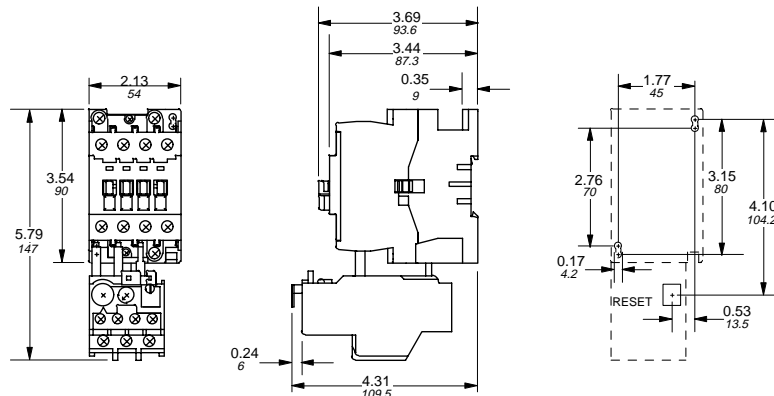

A26 + VM5 or VE5 + TA25 — Reversing starter, 3 pole, AC operated

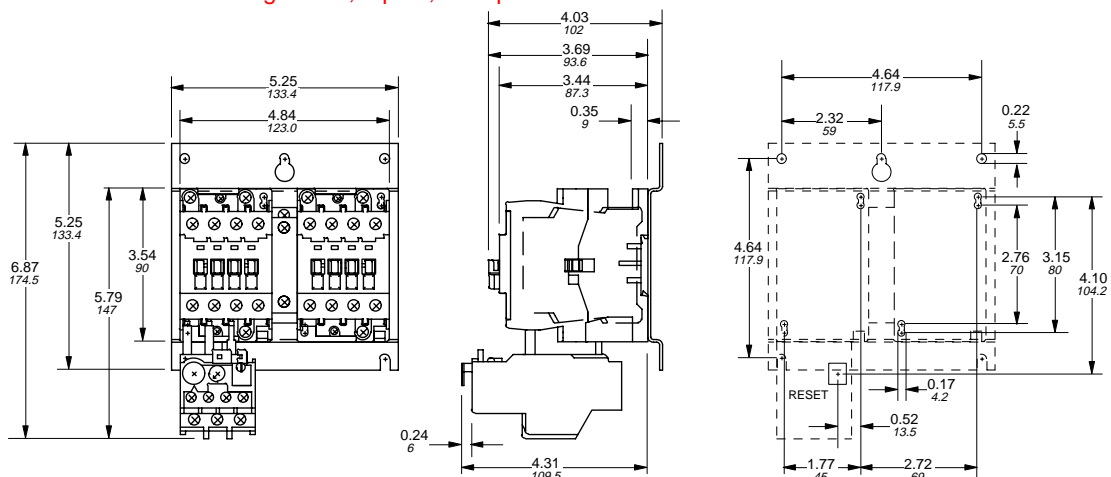

AC 1030 - 6/98

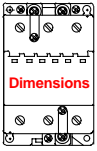

Approximate dimensions for 3 pole, AC operated A contactors & starters A30 & A40

00.00 — Inches
00.00 — Millimeters

A30 & A40 — Contactor, 3 pole, AC operated

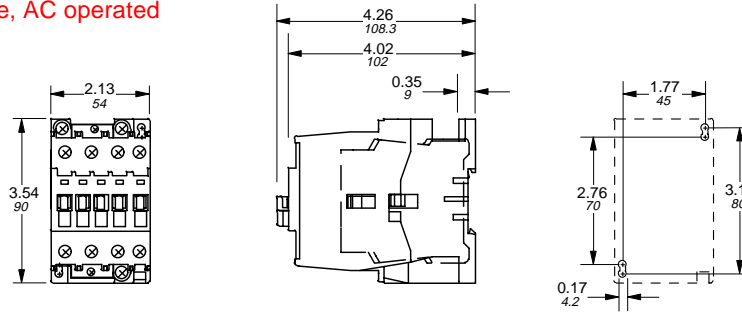

A30 & A40 + VM5 or VE5 — Mechanically interlocked contactor, 3 pole, AC operated

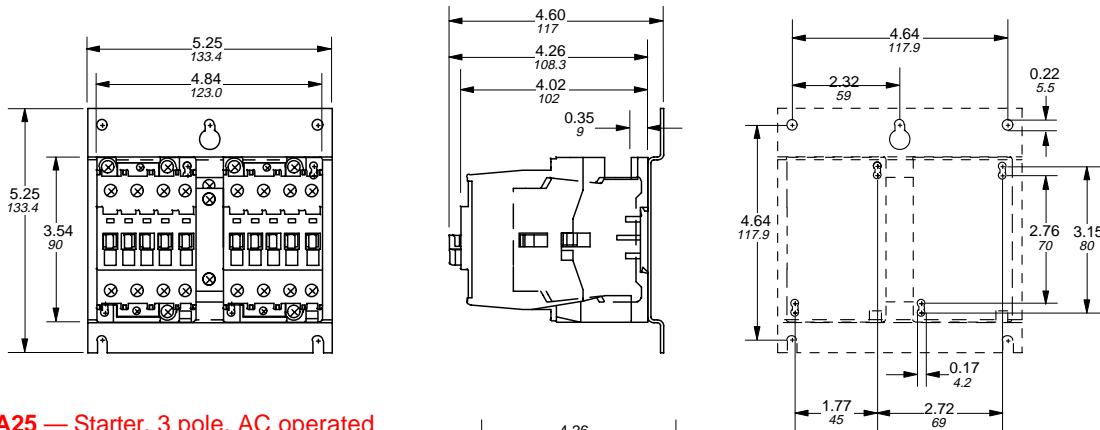

A30 & A40 + TA25 — Starter, 3 pole, AC operated

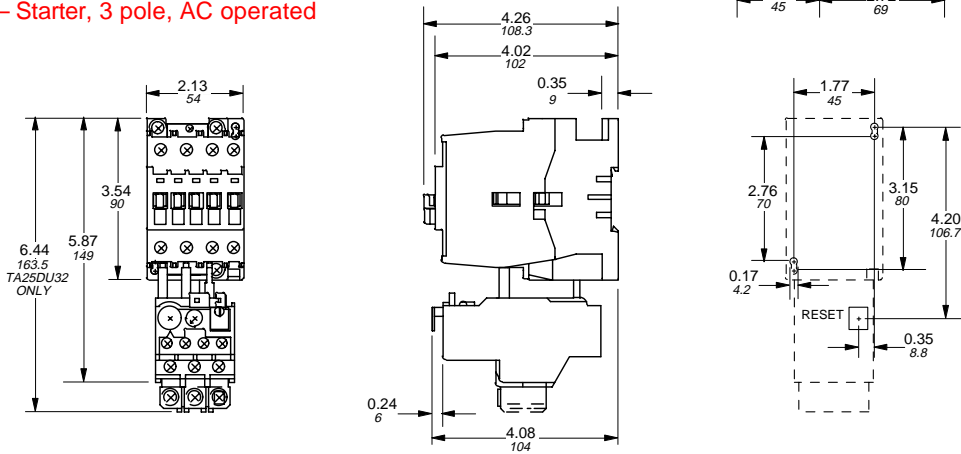

A30 & A40 + TA42 — Starter, 3 pole, AC operated

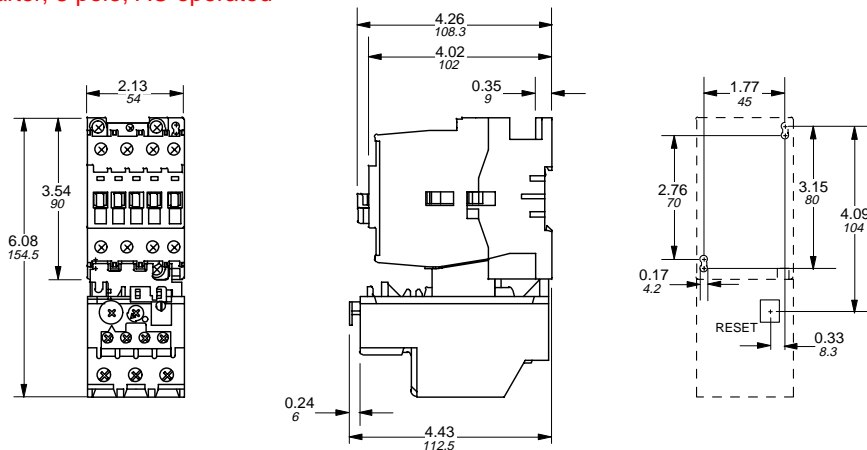

Contactors

Approximate dimensions for 3 pole, AC & DC operated A contactors & starters A30 – A(E)75

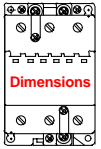

00.00 Inches
00.00 Millimeters

A30 & A40 + VM5 or VE5 + TA25 — Reversing starter, 3 pole, AC operated

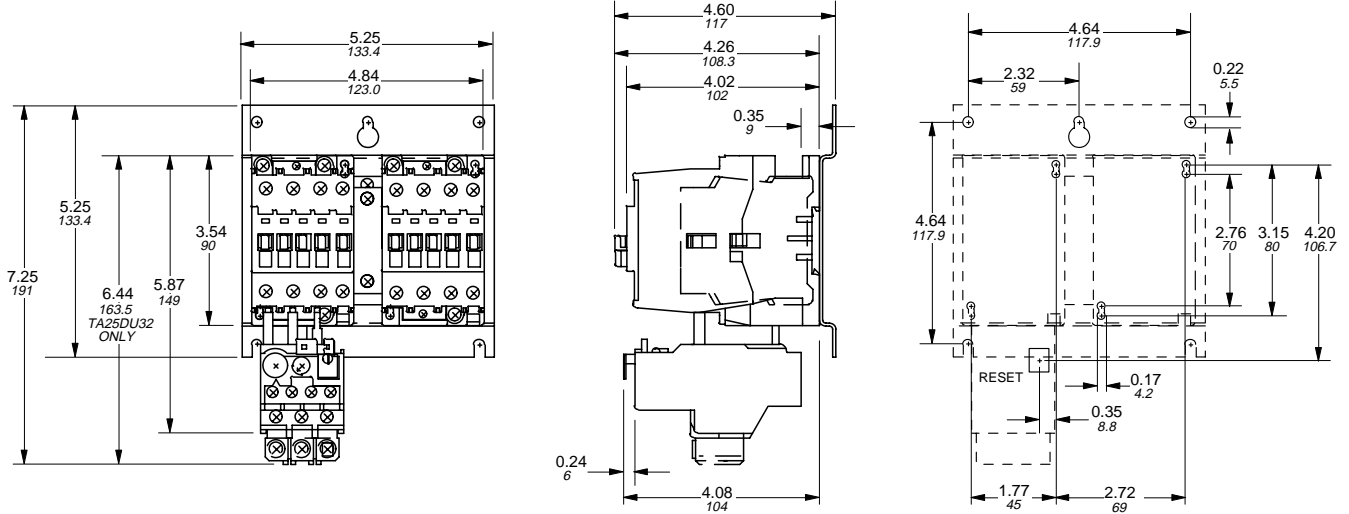

A30 & A40 + VM5 or VE5 + TA42 — Reversing starter, 3 pole, AC operated

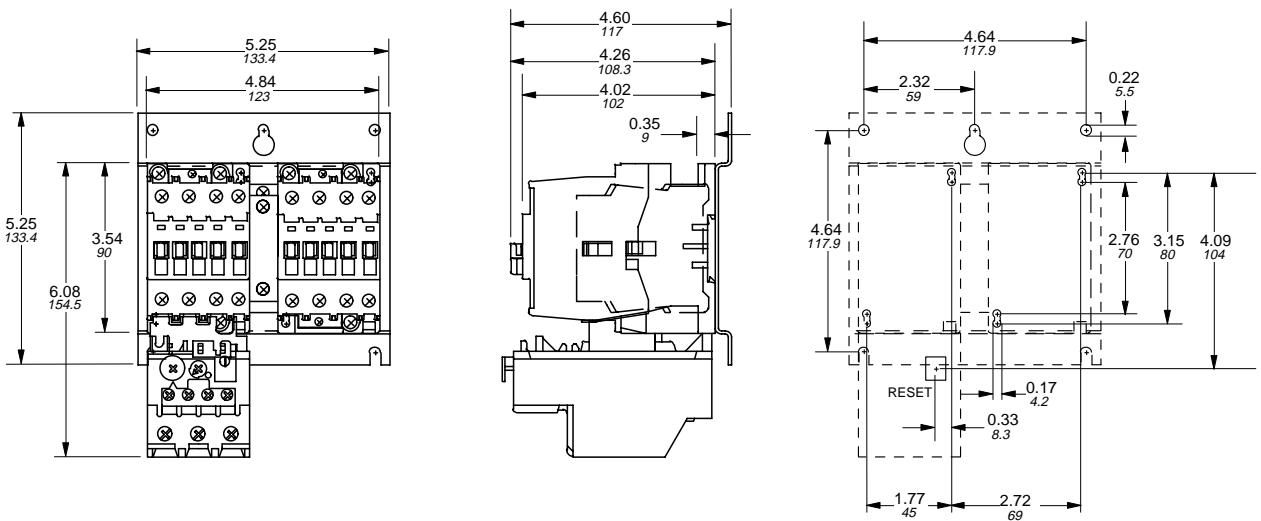

A(E)50 – A(E)75 — Contactor, 3 pole, AC & DC operated

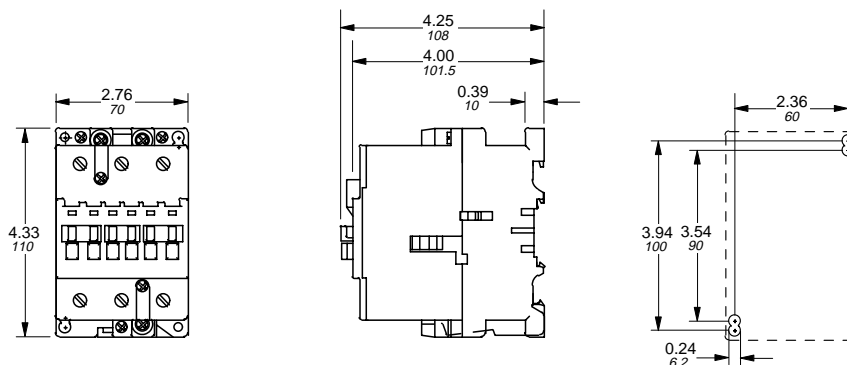

Contactors

AC 1030 – 6/98

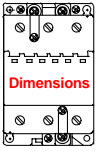

Approximate dimensions for 3 pole, AC & DC operated A contactors & starters A(E)50 – A(E)75

← 00.00 Inches
00.00 Millimeters →

A(E)50 – A(E)75 + VM5 or VE5 — Mechanically interlocked contactor, 3 pole, AC & DC operated

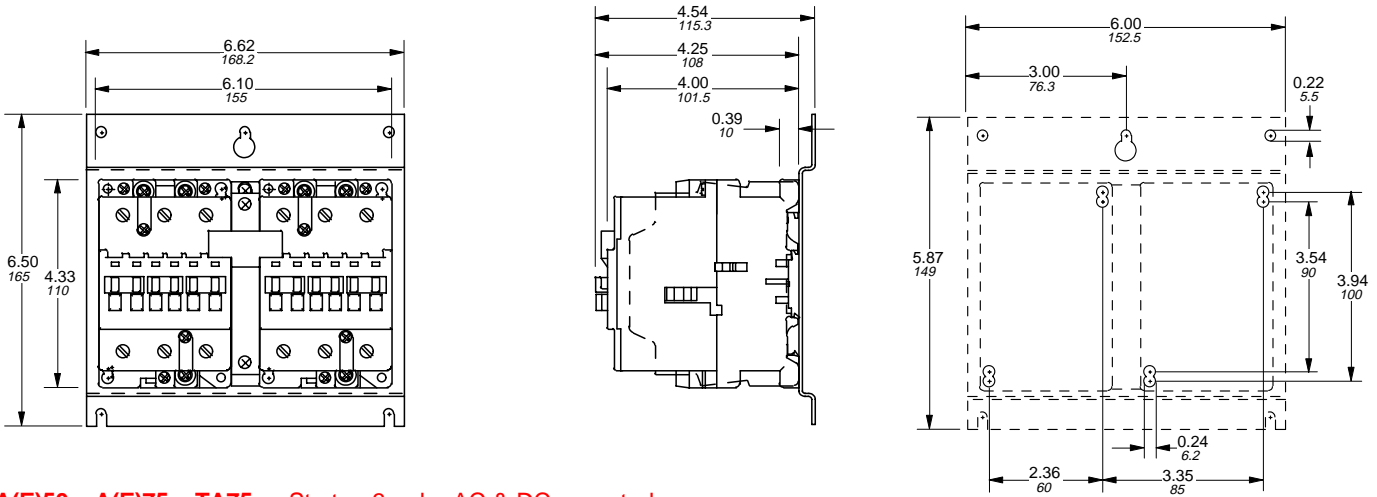

A(E)50 – A(E)75 + TA75 — Starter, 3 pole, AC & DC operated

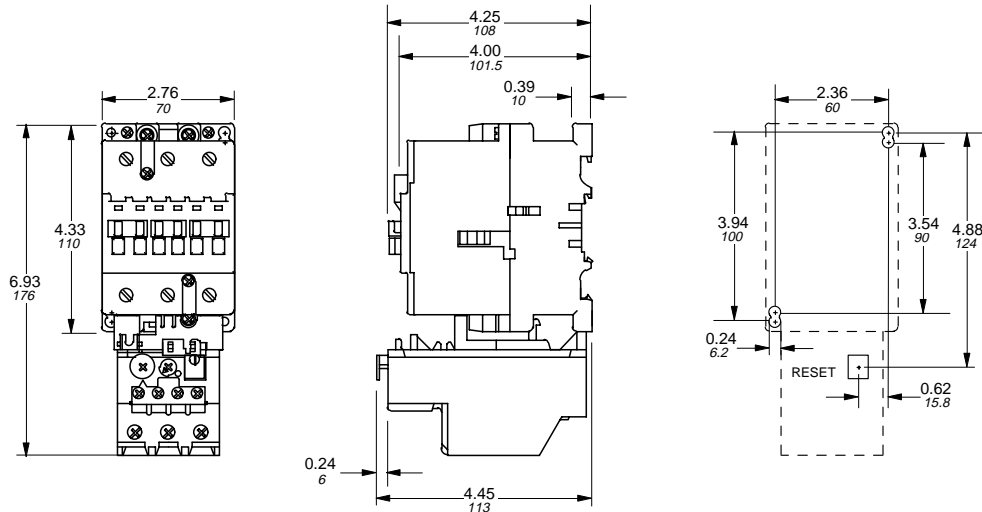

A(E)50 – A(E)75 + VM5 or VE5 + TA75 — Reversing starter, 3 pole, AC & DC operated

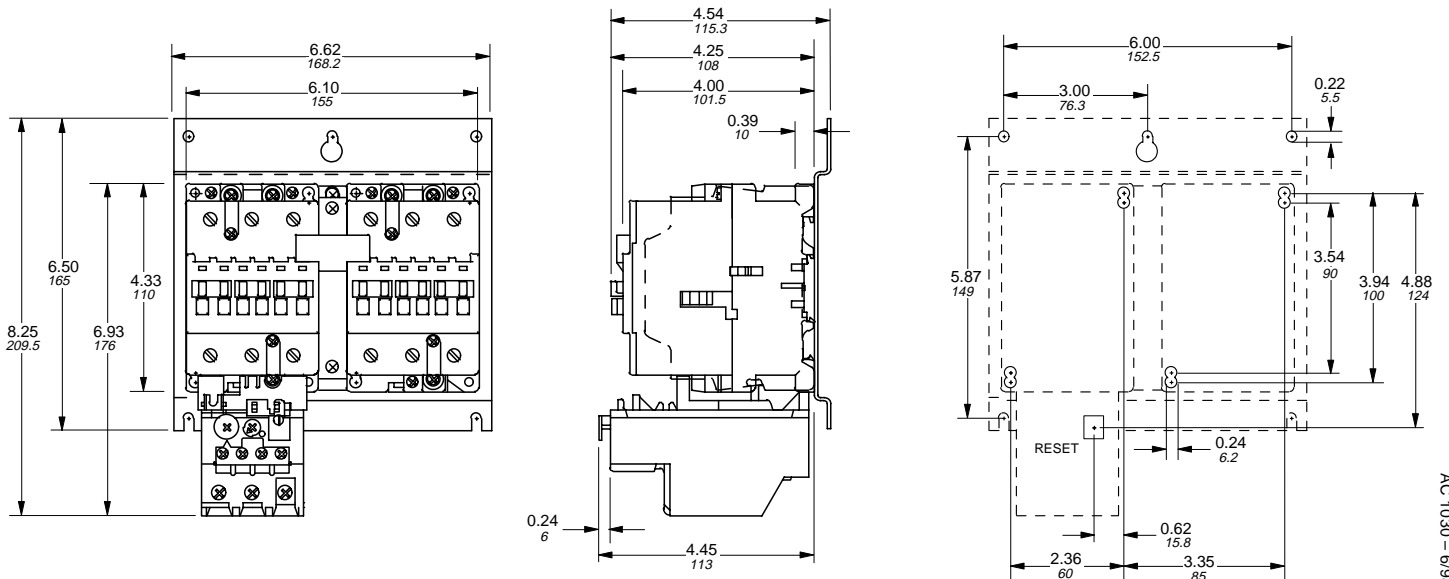

AC 1030 – 698

Approximate dimensions for 3 pole, AC & DC operated A contactors & starters A(E)95 & A(E)110

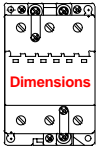

00.00 Inches
00.00 Millimeters

A(E)95 & A(E)110 — Contactor, 3 pole, AC & DC operated

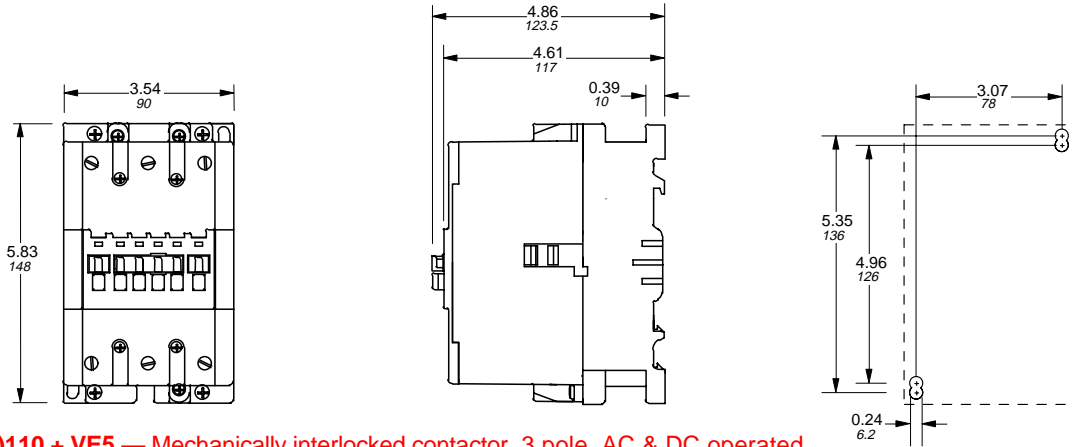

A(E)95 & A(E)110 + VE5 — Mechanically interlocked contactor, 3 pole, AC & DC operated

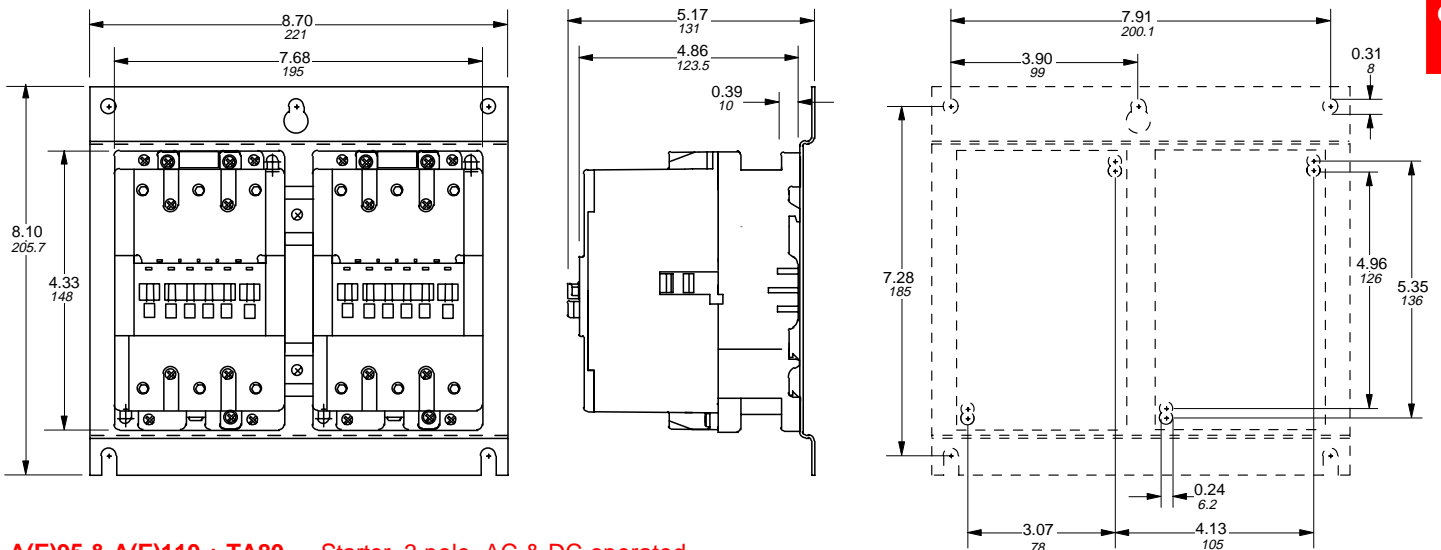

A(E)95 & A(E)110 + TA80 — Starter, 3 pole, AC & DC operated

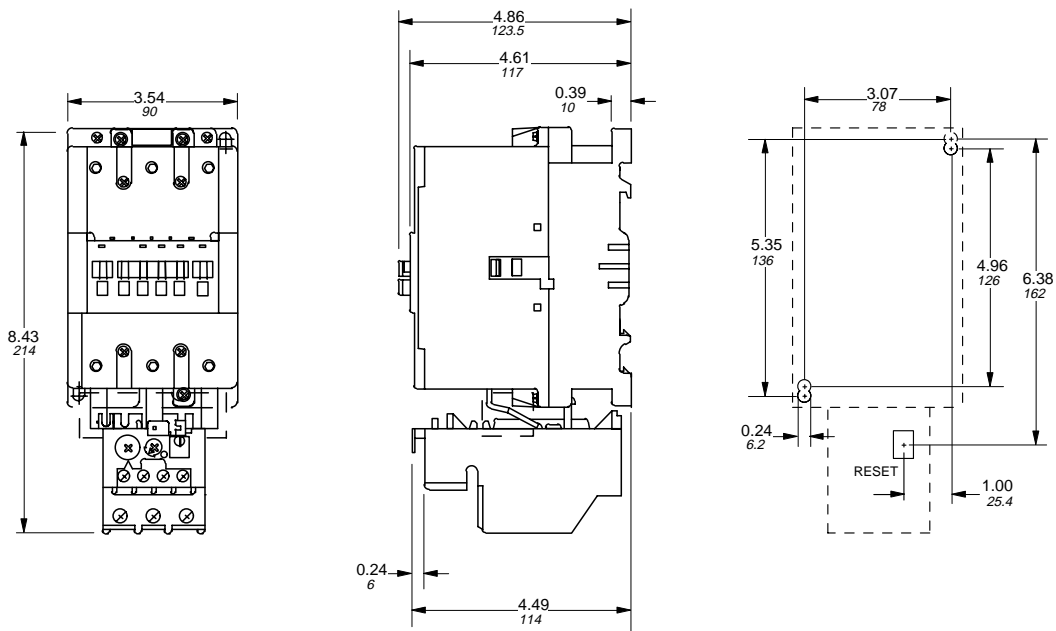

Contactors

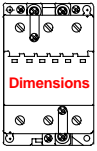

Approximate dimensions for 3 pole, AC & DC operated A contactors & starters A(E)95 & A(E)110

← 00.00 Inches
00.00 Millimeters →

A(E)95 & A(E)110 + TA110 — Starter, 3 pole, AC & DC operated

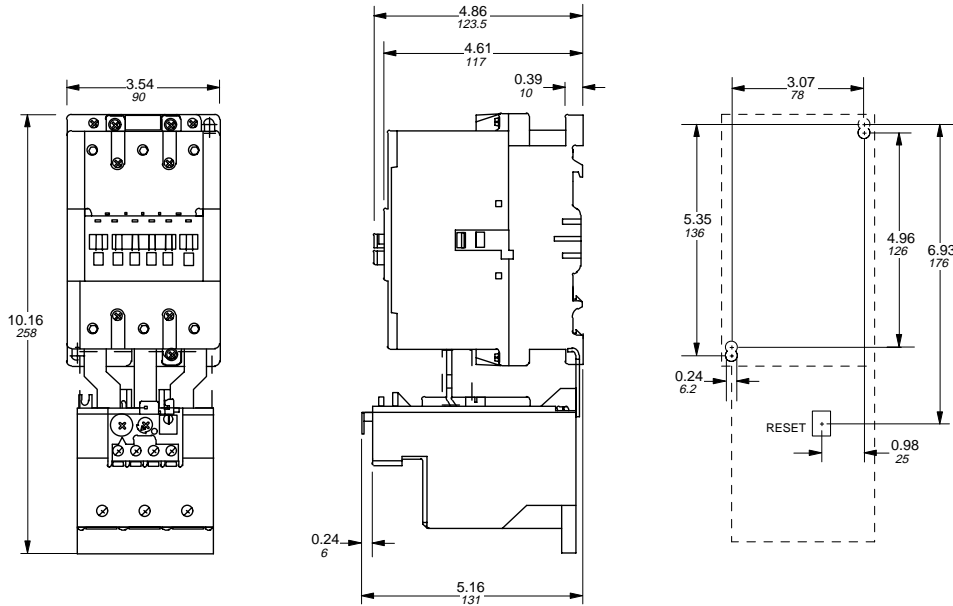

A(E)95 & A(E)110 + VE5 + TA80 — Reversing starter, 3 pole, AC & DC operated

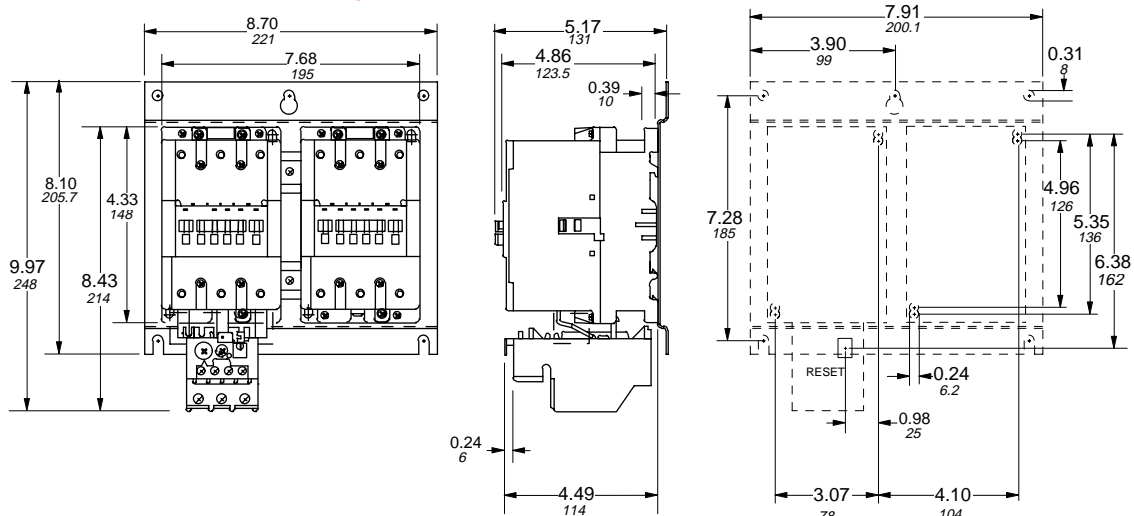

A(E)95 & A(E)110 + VE5 + TA110 — Reversing starter, 3 pole, AC & DC operated

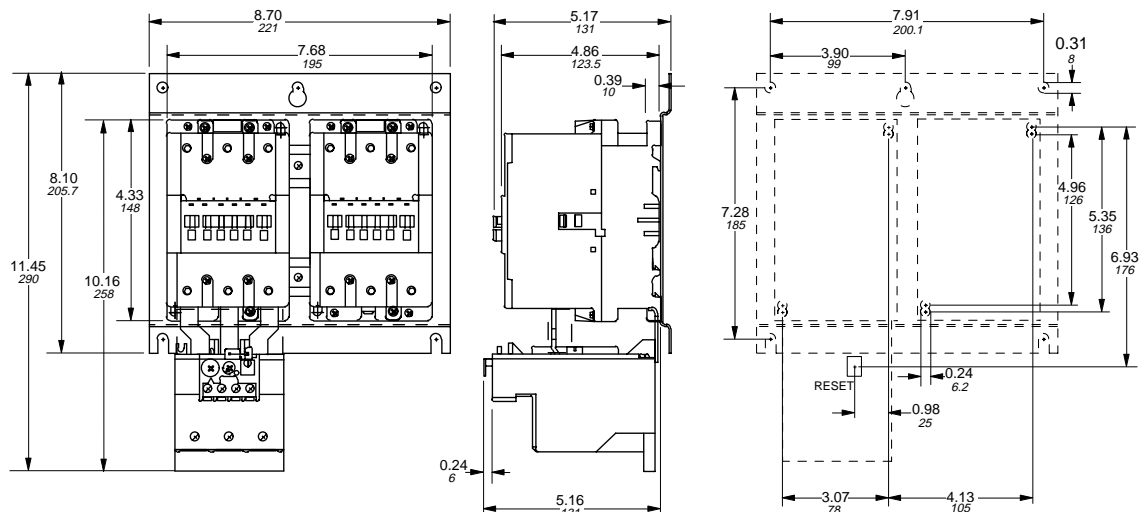

Approximate dimensions for 4 pole, AC & DC operated A contactors & starters A9 – A(E)75

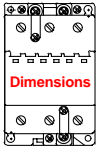

00.00 Inches
00.00 Millimeters

A9 – A16 — Contactor, 4 pole, AC operated

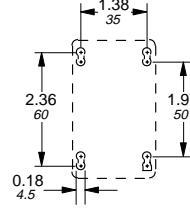
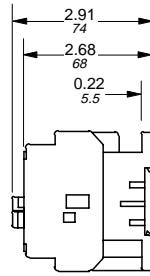
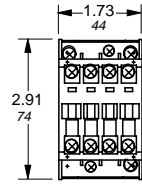

A26 — Contactor, 4 pole, AC operated

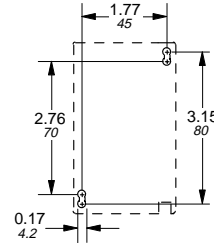
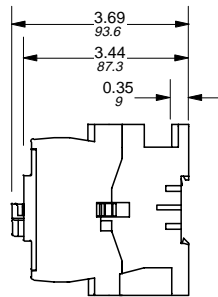
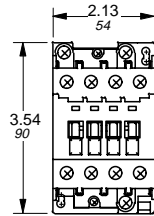

A(E)45 — Contactor, 4 pole, AC & DC operated

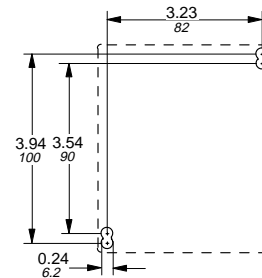
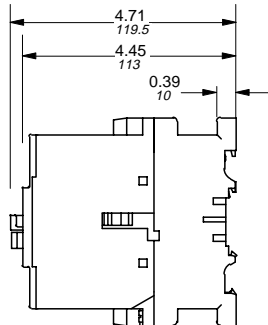
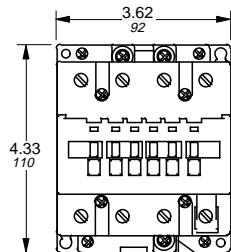

A(E)50 – A(E)75 — Contactor, 4 pole, AC & DC operated

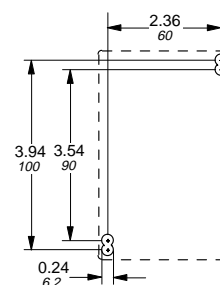
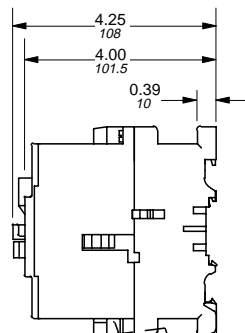
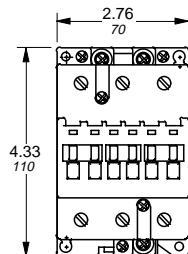

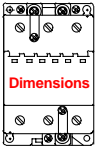

Approximate dimensions for 3 & 4 pole, DC operated BC contactors BC9 – BC30

← 00.00 → Inches
00.00 → Millimeters

BC9 & BC16 — Contactor, 3 & 4 pole, DC operated

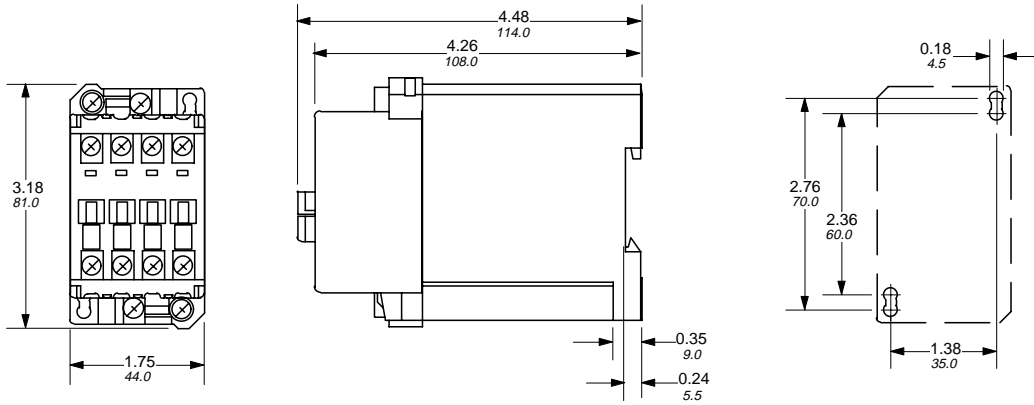

BC25 — Contactor, 3 & 4 pole, DC operated

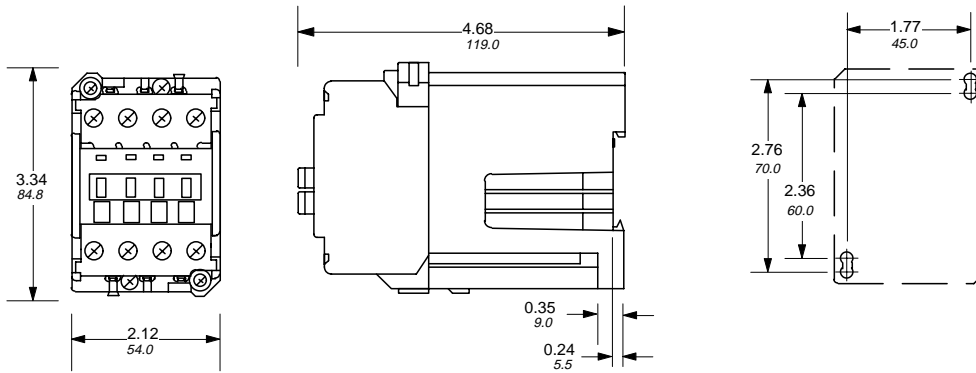

BC30 — Contactor, 3 pole, DC operated

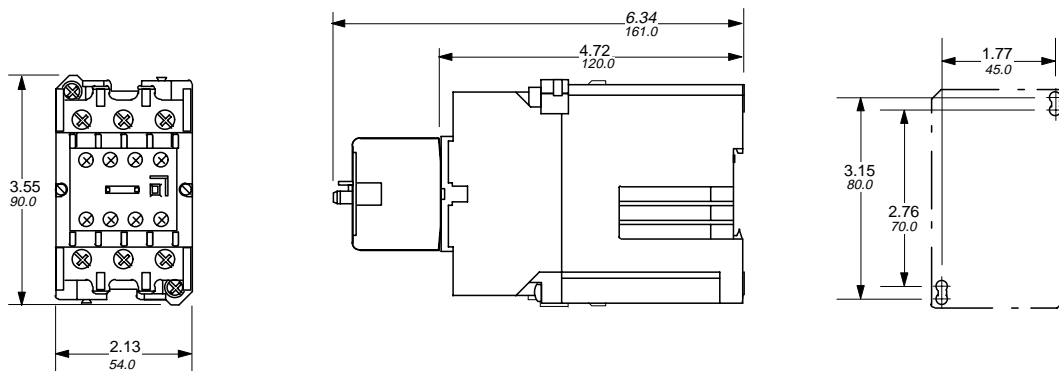

Approximate dimensions for A & BC contactors Accessories for A9 – A(E)110; BC9 – BC30

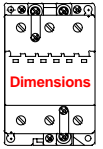

00.00 Inches
00.00 Millimeters

A9 - A(E)110 BC9 - BC30

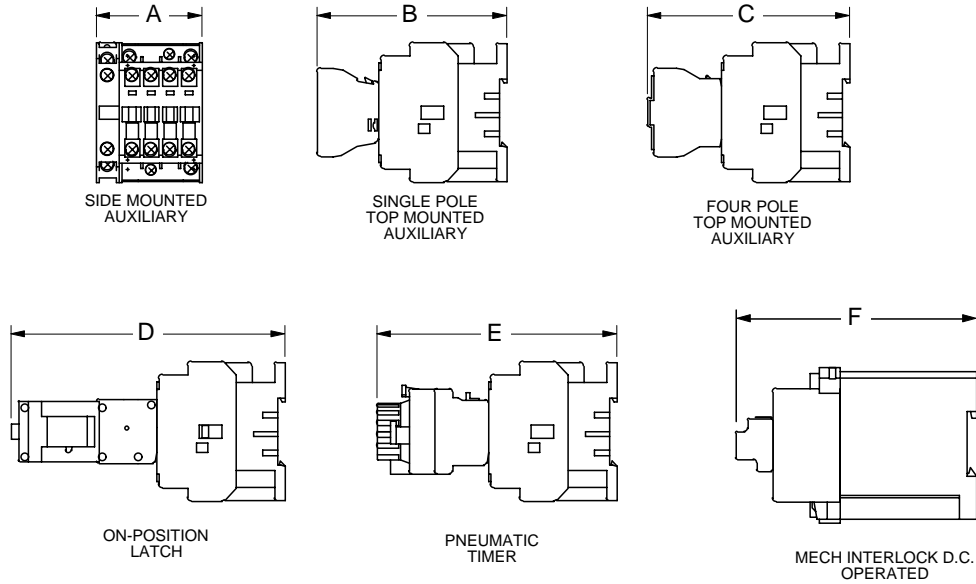

TYPE		A	B	C	D	E	F
A9-16	IN MM	2.20 56	3.96 100.5	4.21 107	5.71 145	5.00 127	– –
A26	IN MM	2.20 56	4.72 119.8	4.97 126.3	6.47 164.3	5.76 146.3	– –
A30-40	IN MM	2.20 56	5.30 134.5	5.55 141	7.05 179	6.34 161	– –
A50-75 AE50-75	IN MM	3.23 82	5.27 133.9	5.52 140.3	7.03 178.5	6.32 160.4	– –
A45	IN MM	4.09 104	5.73 145.5	5.98 152	7.48 190	6.77 172	– –
A95-110 AE95-110	IN MM	4.02 102	5.91 150	6.16 156.5	– –	– –	– –
BC9, BC16	IN MM	– –	5.53 140.5	5.79 147	7.28 185	6.58 167	5.04 128
BC25	IN MM	– –	5.77 146.5	6.02 153	7.52 191	6.81 173	5.28 134
BC30	IN MM	– –	– –	– –	– –	– –	5.51 140