

IGBT MODULE

600V / 30A / PIM

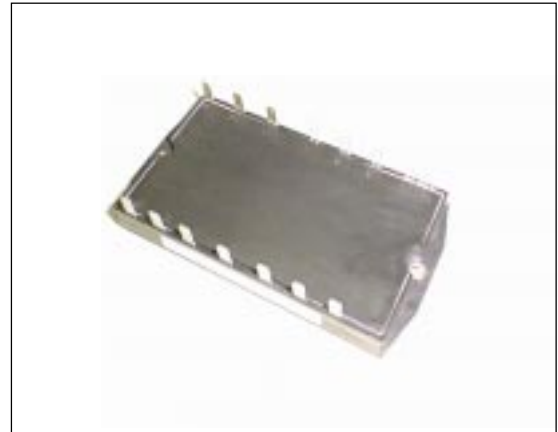

■ Features

- High Speed Switching
- Voltage Drive
- Low Inductance Module Structure
- Converter Diode Bridge Dynamic Brake Circuit

■ Applications

- Inverter for Motor Drive
- AC and DC Servo Drive Amplifier
- Uninterruptible Power Supply

■ Maximum ratings and characteristics

● Absolute maximum ratings (Tc=25°C unless without specified)

Item	Symbol	Condition	Rating	Unit	
Inverter	Collector-Emitter voltage	V _{CES}	600	V	
	Gate-Emitter voltage	V _{GES}	±20	V	
	Collector current	I _C	Continuous	30	A
		I _{CP}	1ms	60	A
		-I _C		30	A
Collector power dissipation	P _C	1 device	120	W	
Brake	Collector-Emitter voltage	V _{CES}	600	V	
	Gate-Emitter voltage	V _{GES}	±20	V	
	Collector current	I _C	Continuous	30	A
		I _{CP}	1ms	60	A
	Collector power dissipation	P _C	1 device	120	W
	Repetitive peak reverse voltage	V _{R_{RM}}		600	V
	Average forward current	I _{F(AV)}		1	A
Surge current	I _{FSM}	10ms	50	A	
Converter	Repetitive peak reverse voltage	V _{R_{RM}}	800	V	
	Non-Repetitive peak reverse voltage	V _{R_S}	900	V	
	Average output current	I _O	50Hz/60Hz sine wave	50	A
	Surge current (Non-Repetitive)	I _{FSM}	T _J =150°C, 10ms	350	A
	I ² t (Non-Repetitive)		T _J =150°C, 10ms	648	A ² s
Operating junction temperature	T _J		+150	°C	
Storage temperature	T _{stg}		-40 to +125	°C	
Isolation voltage	V _{iso}	AC : 1 minute	AC 2500	V	
Mounting screw torque			1.7 * ₁	N·m	

*₁ Recommendable value : 1.3 to 1.7 N·m (M4)

● Electrical characteristics (Tj=25°C unless without specified)

Item	Symbol	Condition	Characteristics			Unit	
			Min.	Typ.	Max.		
Inverter (IGBT)	Zero gate voltage collector current	ICES	VCE=600V, VGE=0V			1.0	mA
	Gate-Emitter leakage current	IGES	VCE=0V, VGE=±20V			20	µA
	Gate-Emitter threshold voltage	VGE(th)	VCE=20V, Ic=30mA			4.5	V
	Collector-Emitter saturation voltage	VCE(sat)	VGE=15V, Ic=30A			2.8	V
	Collector-Emitter voltage	-VCE	-Ic=30A			3.0	V
	Input capacitance	Cies	VGE=0V, VCE=10V, f=1MHz			1980	pF
	Switching time	ton	VCC=300V			1.2	µs
		tr	Ic=30A			0.6	µs
		toff	VGE=±15V			1.0	µs
		tf	RG=82 ohm			0.35	µs
Reverse recovery time of FRD	trr	IF=30A			0.3	µs	
Brake (IGBT)	Zero gate voltage collector current	ICES	VCE=600V, VGE=0V			1.0	mA
	Gate-Emitter leakage current	IGES	VCE=0V, VGE=±20V			0.1	µA
	Collector-Emitter saturation voltage	VCE(sat)	Ic=30A, VGE=15V			2.8	V
	Switching time	ton	VCC=300V			0.8	µs
		tr	Ic=30A			0.6	µs
		toff	VGE=±15V			1.0	µs
tf		RG=82ohm			0.35	µs	
Brake (FWD)	Reverse current	IRRM	VR=600V			1.0	mA
	Reverse recovery time	trr				0.6	µs
Converter	Forward voltage	VFM	IF=50A			1.55	V
	Reverse current	IRRM	VR=800V			1.0	mA

● Thermal Characteristics

Item	Symbol	Condition	Characteristics			Unit
			Min.	Typ.	Max.	
Thermal resistance (1 device)	Rth(j-c)	Inverter IGBT			1.04	°C/W
		Inverter FRD			2.22	
		Brake IGBT			1.04	
		Converter Diode			2.10	
Contact thermal resistance *	Rth(c-f)	With thermal compound		0.05		

* This is the value which is defined mounting on the additional cooling fin with thermal compound

■ Equivalent Circuit Schematic

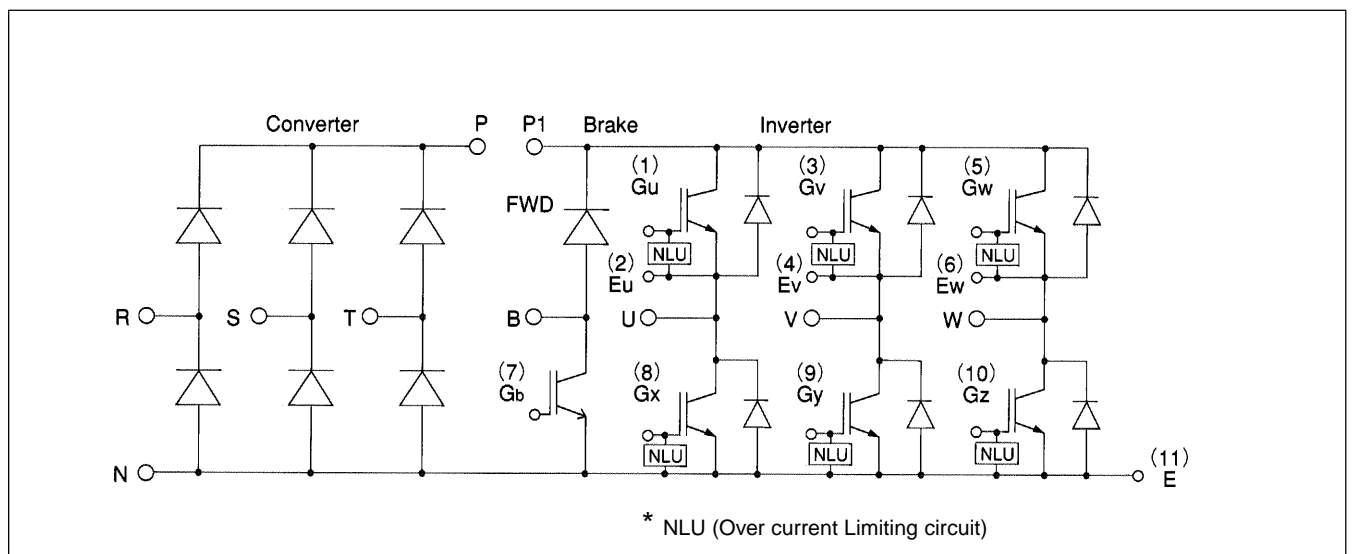

■ Characteristics (Representative)

Collector current vs. Collector-Emitter voltage
T_J=25°C

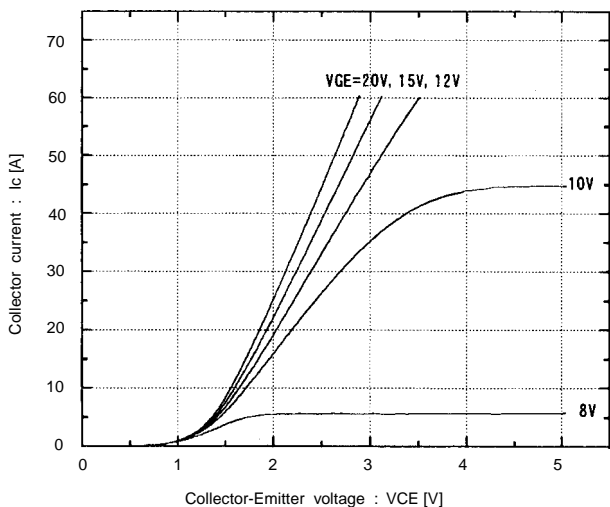

Collector current vs. Collector-Emitter voltage
T_J=125°C

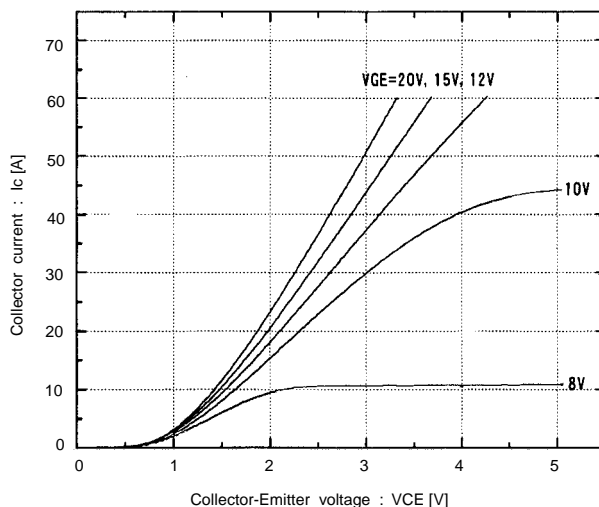

Collector-Emitter vs. Gate-Emitter voltage
T_J=25°C

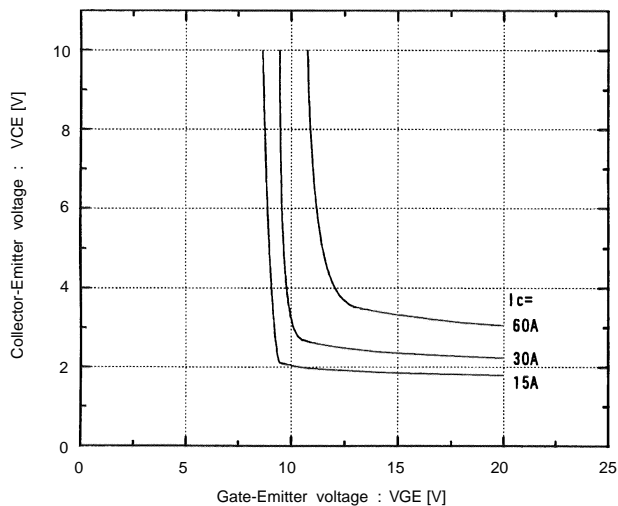

Collector-Emitter vs. Gate-Emitter voltage
T_J=125°C

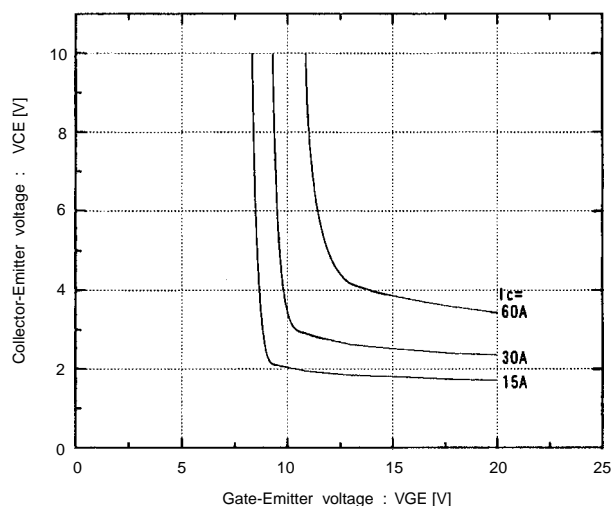

Switching time vs. Collector current
V_{cc}=300V, R_G=82 ohm, V_{GE}=±15V, T_J=25°C

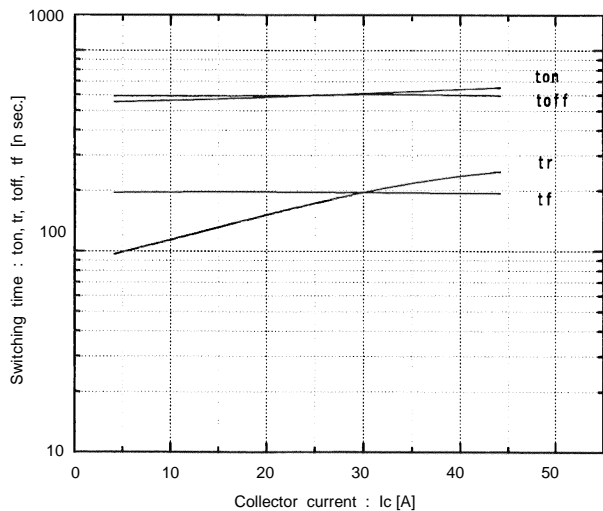

Switching time vs. Collector current
V_{cc}=300V, R_G=82 ohm, V_{GE}=±15V, T_J=125°C

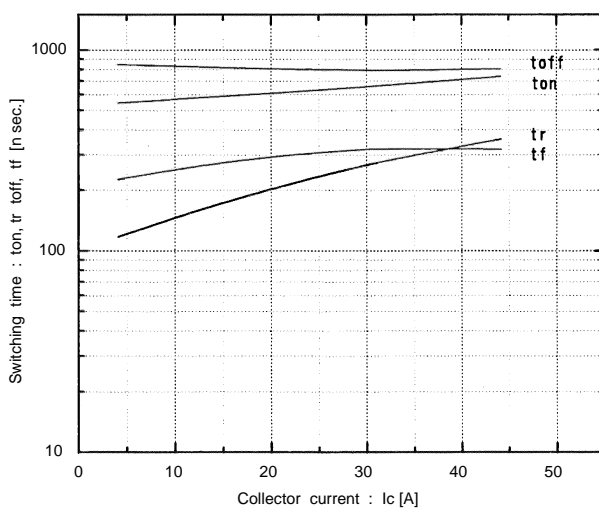

Switching time vs. RG
 $V_{cc}=300V, I_c=30A, V_{GE}=\pm 15V, T_j=25^\circ C$

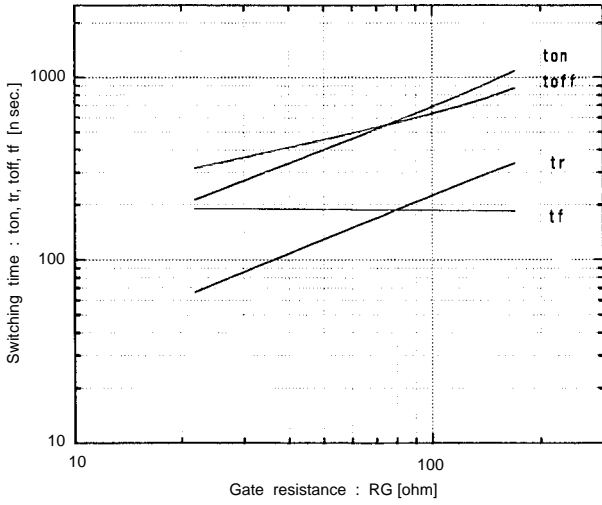

Dynamic input characteristics
 $T_j=25^\circ C$

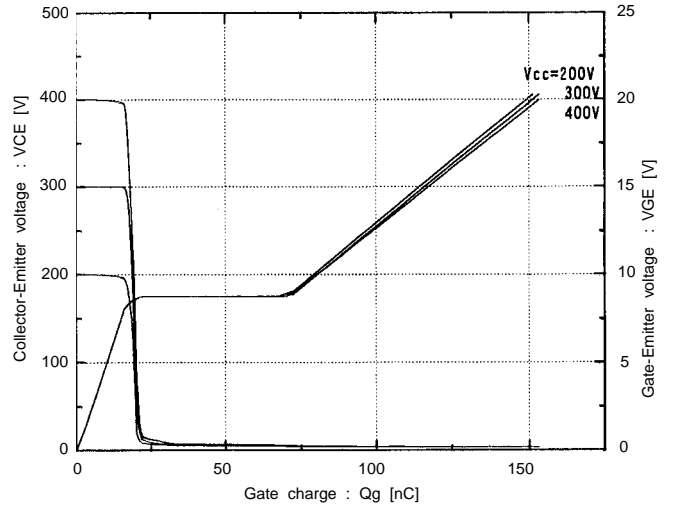

FWD
 Forward current vs. Forward voltage
 $V_{GE}=0V$

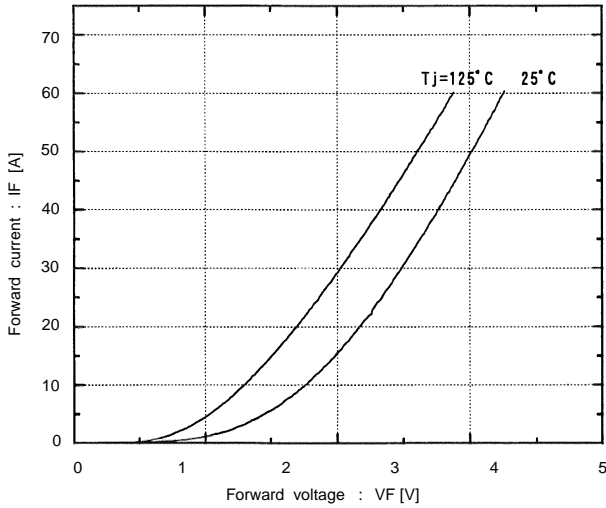

Reverse recovery characteristics
 t_{rr}, I_{rr} vs. I_F

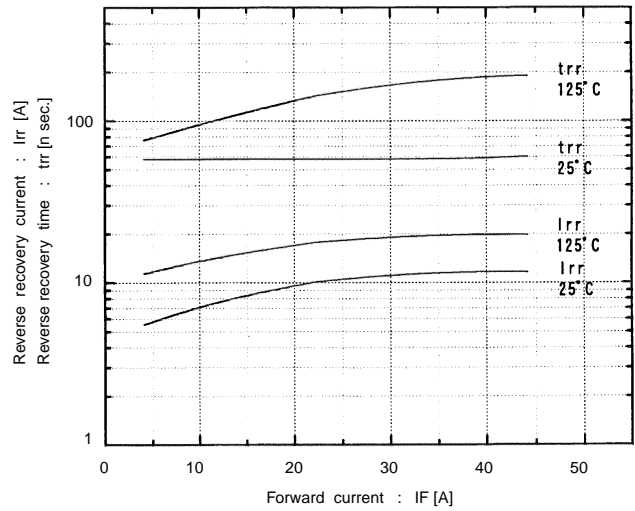

Transient thermal resistance

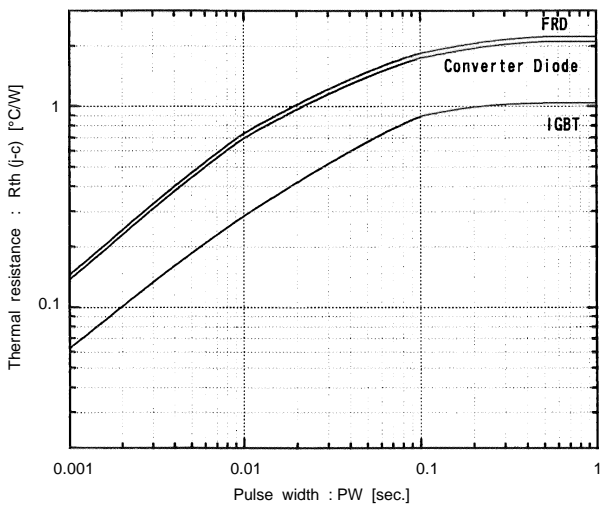

Reversed biased safe operating area
 $+V_{GE}=15V, -V_{GE} \le 15V, T_j \le 125^\circ C, R_G \ge 82 \text{ ohm}$

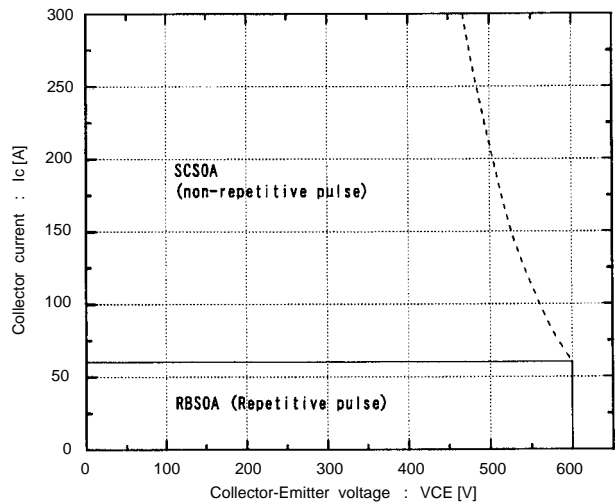

Switching loss vs. Collector current
 $V_{cc}=300V, R_G=82\ \text{ohm}, V_{GE}=\pm 15V$

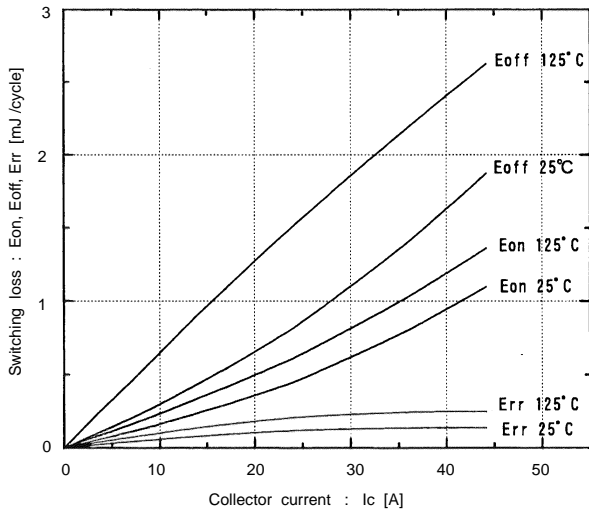

Capacitance vs. Collector-Emitter voltage
 $T_j=25^\circ\text{C}$

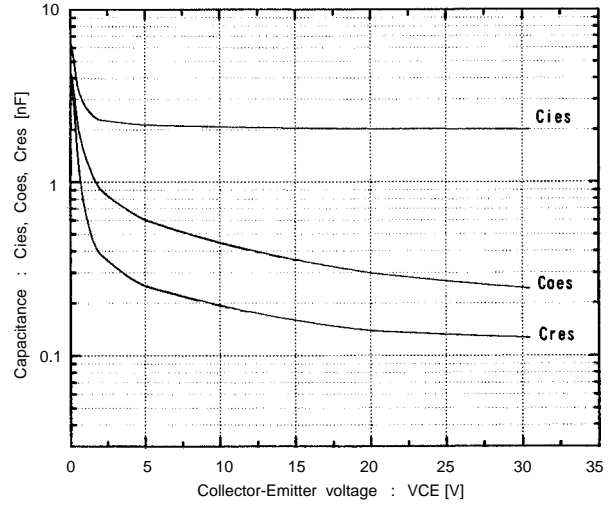

Converter Diode
 Forward current vs. Forward voltage

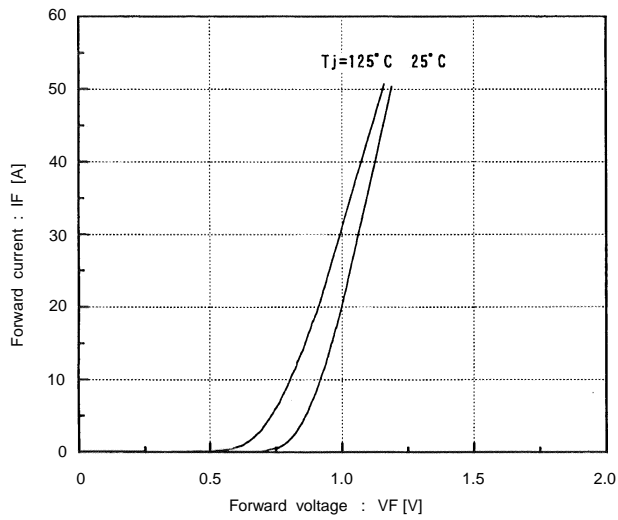

■ Outline Drawings, mm

