

7MBP50TEA060

Econo IPM series

600V / 50A 7 in one-package

Features

- Temperature protection provided by directly detecting the junction temperature of the IGBTs
- Low power loss and soft switching
- High performance and high reliability IGBT with overheating protection
- Higher reliability because of a big decrease in number of parts in built-in control circuit



Maximum ratings and characteristics

- Absolute maximum ratings(at Tc=25°C unless otherwise specified)

Item	Symbol	Rating		Unit		
		Min.	Max.			
Bus voltage	DC	V _{DC}	0	450	V	
	Surge	V _{DC(surge)}	0	500	V	
	Short operating	V _{SC}	200	400	V	
Collector-Emitter voltage *1		V _{CES}	0	600	V	
Inverter	Collector current	DC	I _C	-	50	A
		1ms	I _{CP}	-	100	A
		Duty=76.1% *2	-I _C	-	50	A
Collector power dissipation	One transistor *3	P _C	-	144	W	
	Collector current	DC	I _C	-	30	A
		1ms	I _{CP}	-	60	A
	Forward current diode		I _F	-	30	A
	Collector power dissipation	One transistor *3	P _C	-	144	W
Supply voltage of Pre-Driver *4		V _{CC}	-0.5	20	V	
Input signal voltage *5		V _{in}	-0.5	V _{CC} +0.5	V	
Input signal current		I _{in}	-	3	mA	
Alarm signal voltage *6		V _{ALM}	-0.5	V _{CC}	V	
Alarm signal current *7		I _{ALM}	-	20	mA	
Junction temperature		T _j	-	150	°C	
Operating case temperature		T _{opr}	-20	100	°C	
Storage temperature		T _{stg}	-40	125	°C	
Solder temperature *8		T _{sol}	-	260	°C	
Isolating voltage (Terminal to base, 50/60Hz sine wave 1min.)		V _{iso}	-	AC2500	V	
Screw torque	Mounting (M5)		-	3.5	N·m	

Note

*1 : V_{ces} shall be applied to the input voltage between terminal P and U or ,u or W, N and U or V or W

*2 : $125^{\circ}\text{C}/\text{FWD } R_{th(j-c)} / (I_c \times V_F \text{ MAX}) = 125 / 1.263 / (50 \times 2.6) \times 100 = 76.1\%$

*3 : P_C=125°C/IGBT R_{th(j-c)}=125/0.87=144W [Inverter]

P_C=125°C/IGBT R_{th(j-c)}=125/0.87=144W [Breake]

*4 : V_{CC} shall be applied to the input voltage between terminal No.4 and 1, 8 and 5, 12 and 9, 14 and 13

*5 : V_{in} shall be applied to the input voltage between terminal No.3 and 1, 7 and 5, 11 and 9, 16,17,18 and 13.

*6 : V_{ALM} shall be applied to the voltage between terminal No.2 and 1, No6 and 5, No10 and 9, No.19 and 13.

*7 : I_{ALM} shall be applied to the input current to terminal No.2,6,10 and 19.

*8 : Immersion time 10±1sec.

Electrical characteristics (at T_c=T_j=25°C, V_{cc}=15V unless otherwise specified.)

● Main circuit

Item		Symbol	Condition	Min.	Typ.	Max.	Unit	
Inverter	Collector current at off signal input	ICES	V _{CE} =600V V _{in} terminal open.	-	-	1.0	mA	
	Collector-Emitter saturation voltage	V _{CE(sat)}	I _c =50A	Terminal	-	-	2.5	V
				Chip	-	2.0	-	
	Forward voltage of FWD	V _F	-I _c =50A	Terminal	-	-	2.6	V
Chip				-	1.6	-		
Brake	Collector current at off signal input	ICES	V _{CE} =600V V _{in} terminal open.	-	-	1.0	mA	
	Collector-Emitter saturation voltage	V _{CE(sat)}	I _c =30A	Terminal	-	-	2.2	V
				Chip	-	1.75	-	
	Forward voltage of Diode	V _F	-I _c =30A	Terminal	-	-	3.3	V
Chip				-	1.9	-		
Turn-on time	ton	V _{DC} =300V, T _j =125°C		1.2	-	-	μs	
Turn-off time	toff	I _c =50A Fig.1, Fig.6		-	-	3.6		
Reverse recovery time	trr	V _{DC} =300V, I _c =50A Fig.1, Fig.6		-	-	0.3		
Maximum Avalanche Energy (A non-repetition)	P _{AV}	Internal wiring inductance=50nH Main circuit wiring inductance=54nH		30	-	-	mJ	

● Control circuit

Item	Symbol	Condition	Min.	Typ.	Max.	Unit
Supply current of P-line side pre-driver(one unit)	I _{ccp}	Switching Frequency : 0 to 15kHz T _c =-20 to 125°C Fig.7	-	-	18	mA
Supply current of N-line side pre-driver	I _{ccn}		-	-	65	mA
Input signal threshold voltage (on/off)	V _{in(th)}	ON	1.00	1.35	1.70	V
		OFF	1.25	1.60	1.95	V
Input zener voltage	V _Z	R _{in} =20k ohm	-	8.0	-	V
Alarm signal hold time	t _{ALM}	T _c =-20°C Fig.2	1.1	-	-	ms
		T _c =25°C Fig.2	-	2.0	-	ms
		T _c =125°C Fig.2	-	-	4.0	ms
Current limit resistor	R _{ALM}	Alarm terminal	1425	1500	1575	ohm

● Protection Section (V_{cc}=15V)

Item	Symbol	Condition	Min.	Typ.	Max.	Unit
Over Current Protection Level of Inverter circuit	I _{oc}	T _j =125°C	75	-	-	A
Over Current Protection Level of Brake circuit	I _{oc}	T _j =125°C	45	-	-	A
Over Current Protection Delay time	t _{DOC}	T _j =125°C	-	5	-	μs
SC Protection Delay time	t _{SC}	T _j =125°C Fig.4	-	-	8	μs
IGBT Chip Over Heating	T _{jOH}	Surface of IGBT chips	150	-	-	°C
Over Heating Protection Hysteresis	T _{jH}		-	20	-	°C
Under Voltage Protection Level	V _{UV}		11.0	-	12.5	V
Under Voltage Protection Hysteresis	V _H		0.2	0.5	-	V

● Thermal characteristics(T_c=25°C)

Item			Symbol	Min.	Typ.	Max.	Unit
Junction to Case thermal resistance *9	Inverter	IGBT	R _{th(j-c)}	-	-	0.87	°C/W
		FWD	R _{th(j-c)}	-	-	1.263	°C/W
	Brake	IGBT	R _{th(j-c)}	-	-	0.87	°C/W
Case to fin thermal resistance with compound			R _{th(c-f)}	-	0.05	-	-°C/W

*9 For 1 device, Case is under the device

● Noise Immunity (V_{DC}=300V, V_{cc}=15V, Test Circuit Fig.5)

Item	Condition	Min.	Typ.	Max.	Unit
Common mode rectangular noise	Pulse width 1μs, polarity ±, 10minuets Judge : no over-current, no miss operating	±2.0	-	-	kV
Common mode lightning surge	Rise time 1.2μs, Fall time 50μs Interval 20s, 10 times Judge : no over-current, no miss operating	±5.0	-	-	kV

● Recommendable value

Item	Symbol	Min.	Typ.	Max.	Unit
DC Bus Voltage	V _{DC}	-	-	400	V
Operating Supply Voltage of Pre-Driver	V _{cc}	13.5	15.0	16.5	V
Screw torque (M5)	-	2.5	-	3.0	Nm

● Weight

Item	Symbol	Min.	Typ.	Max.	Unit
Weight	W _t	-	270	-	g

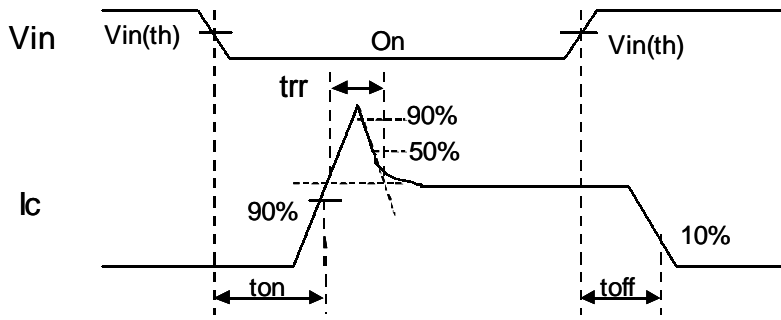

Figure 1. Switching Time Waveform Definitions



Fault : Over-current, Over-heat or Under-voltage

Figure 2. Input/Output Timing Diagram

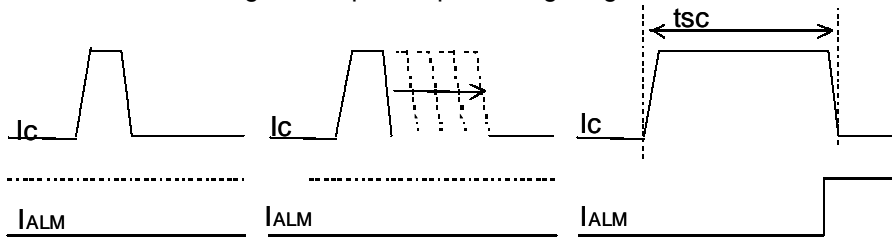

Figure.4 Definition of tsc



Figure 5. Noise Test Circuit

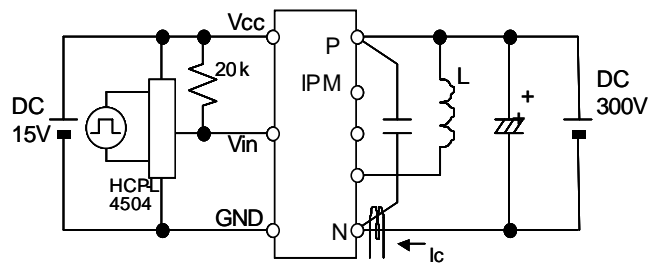

Figure 6. Switching Characteristics Test Circuit

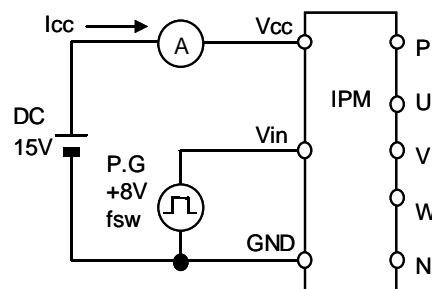
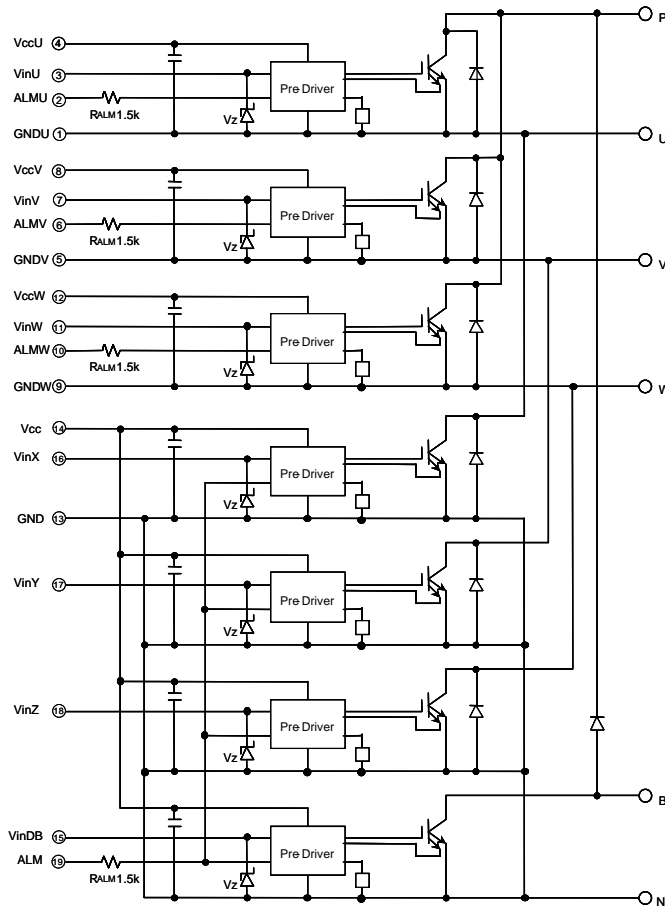

Figure 7. Icc Test Circuit

Block diagram



Pre-drivers include following functions

1. Amplifier for driver
2. Short circuit protection
3. Under voltage lockout circuit
4. Over current protection
5. IGBT chip over heating protection

Outline drawings, mm

Package Type : P622

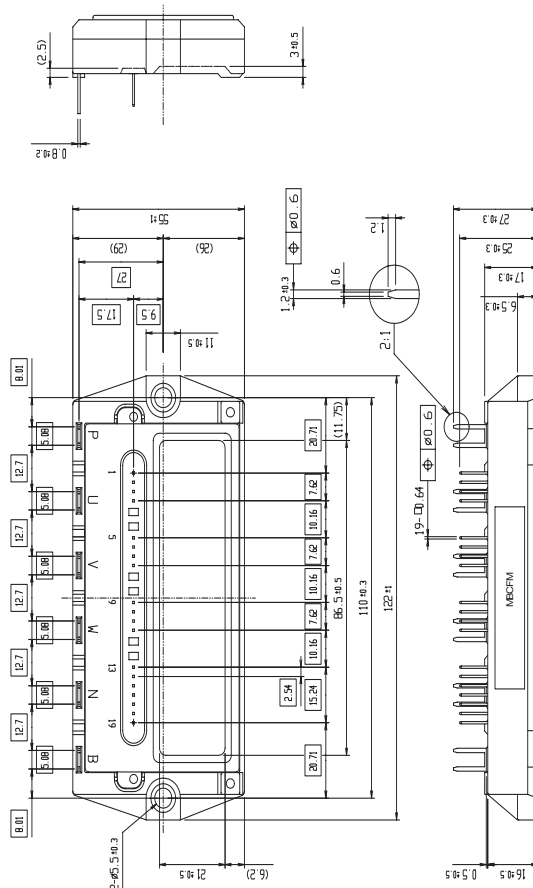

Mass : 270g

Characteristics

Control circuit characteristics (Representative)

Power supply current vs. Switching frequency
Tc=125°C

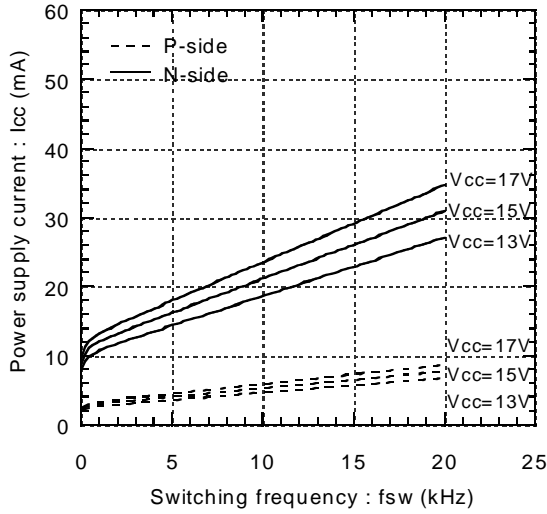

Input signal threshold voltage vs. Power supply voltage
— Tj=25°C
--- Tj=125°C

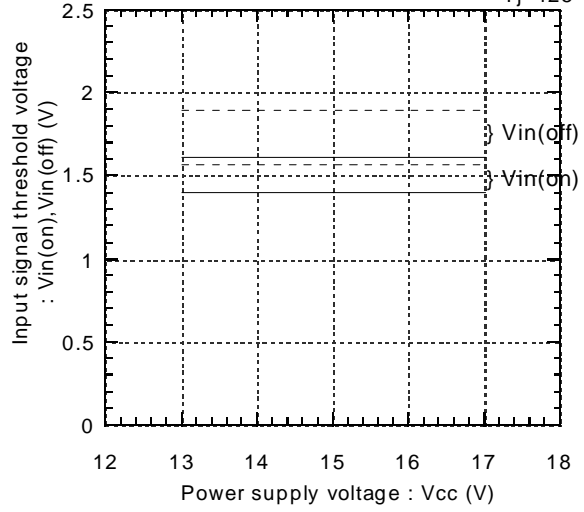

Under voltage vs. Junction temperature

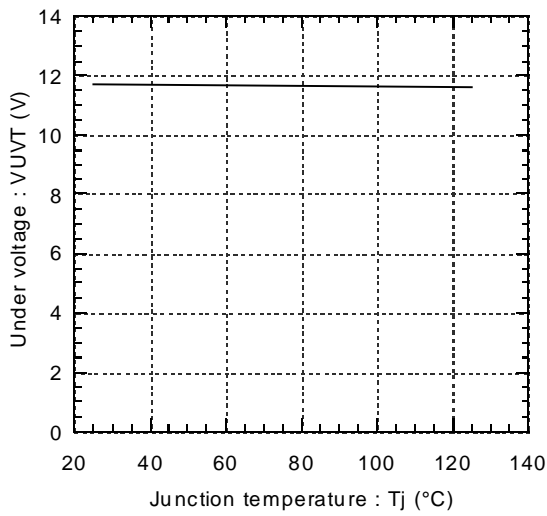

Under voltage hysteresis vs. Junction temperature

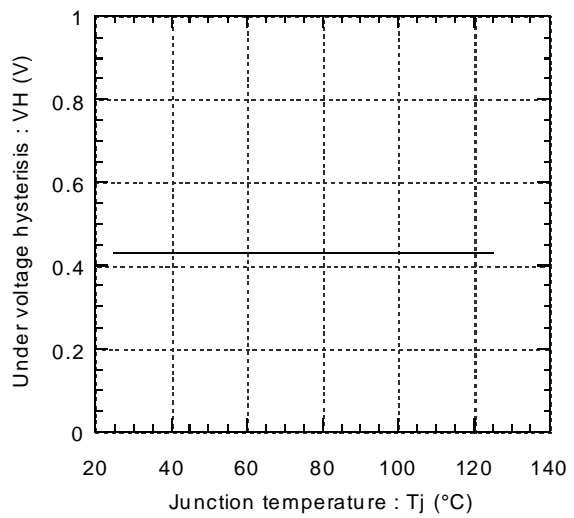

Alarm hold time vs. Power supply voltage

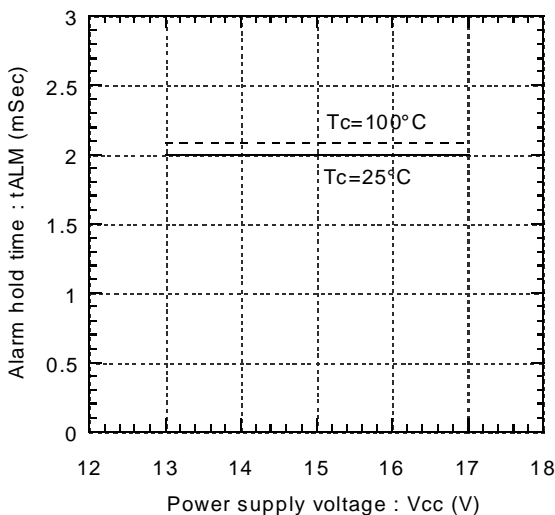

Over heating characteristics
TjOH, TjH vs. Vcc

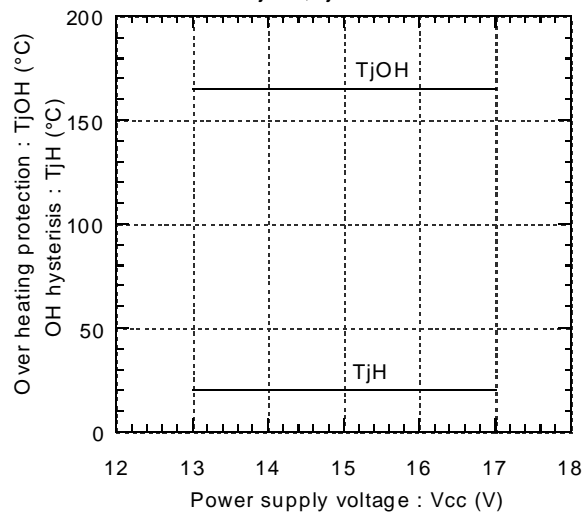

● Main circuit characteristics (Representative)

Collector current vs. Collector-Emmitter voltage
Tj=25°C(Chip)

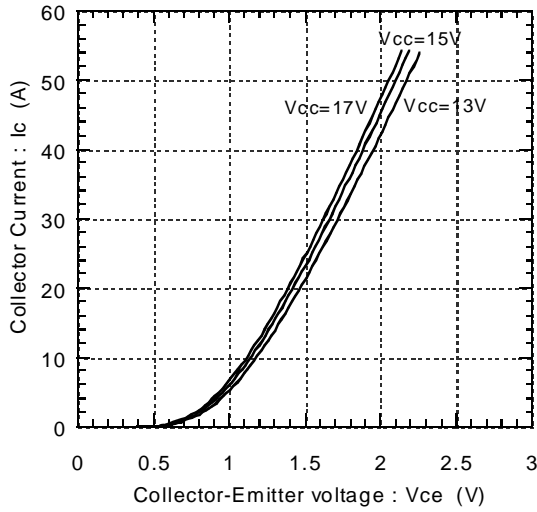

Collector current vs. Collector-Emmitter voltage
Tj=25°C(Terminal)

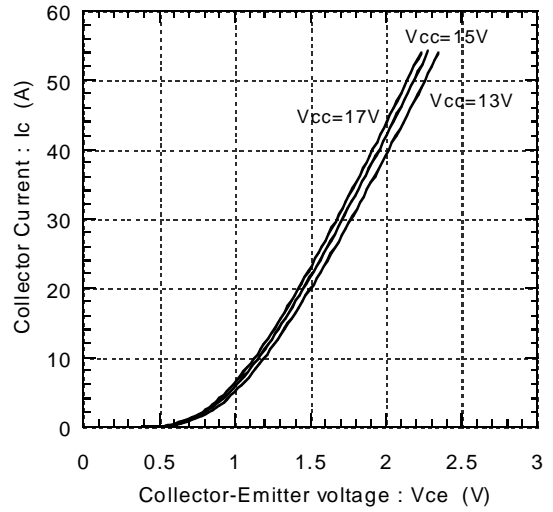

Collector current vs. Collector-Emmitter voltage
Tj=125°C(Chip)

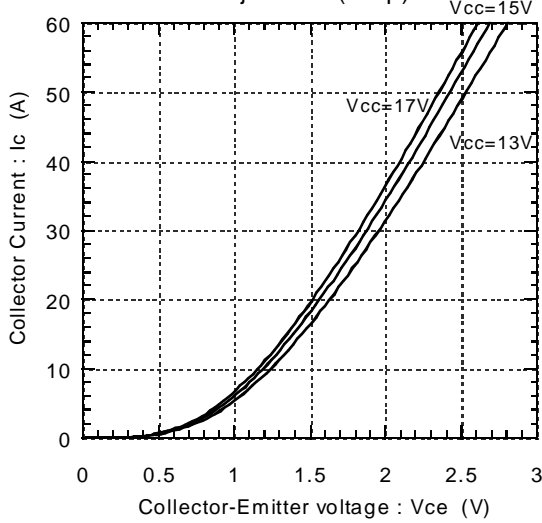

Collector current vs. Collector-Emmitter voltage
Tj=125°C(Terminal)

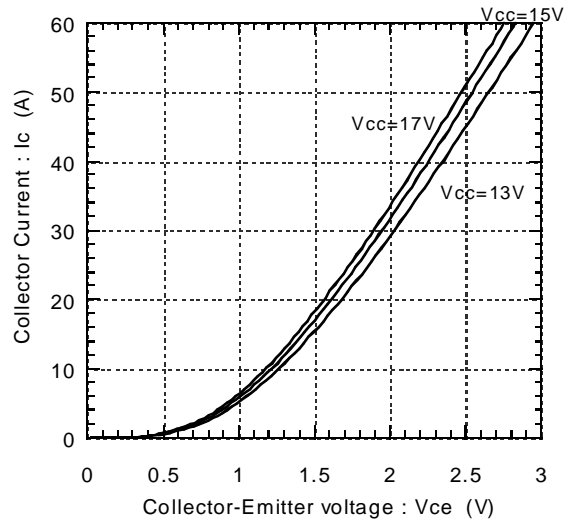

Forward current vs. Forward voltage
(Chip)

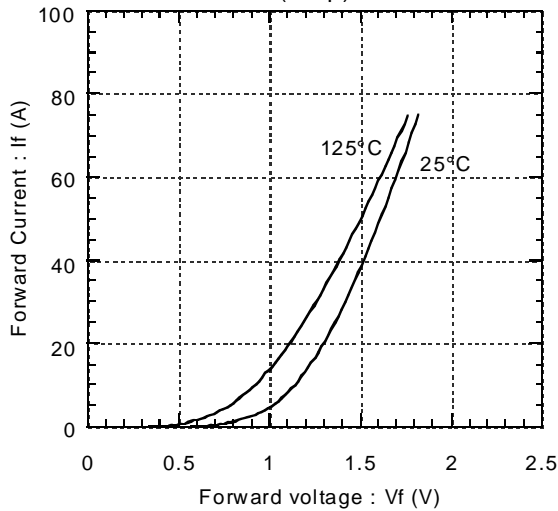

Forward current vs. Forward voltage
(Terminal)

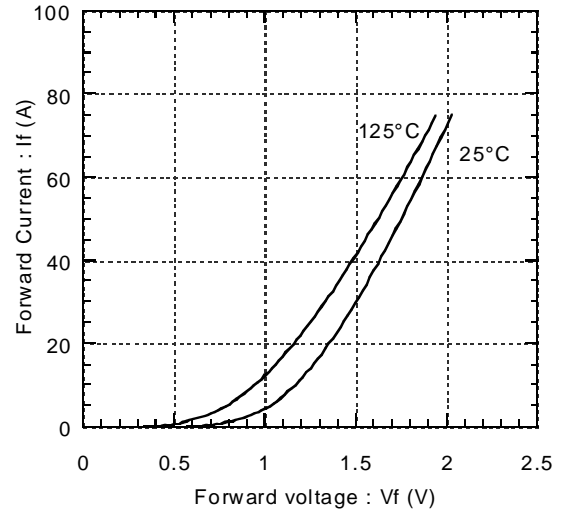

Switching Loss vs. Collector Current
 $E_{dc}=300V, V_{cc}=15V, T_j=25^\circ C$

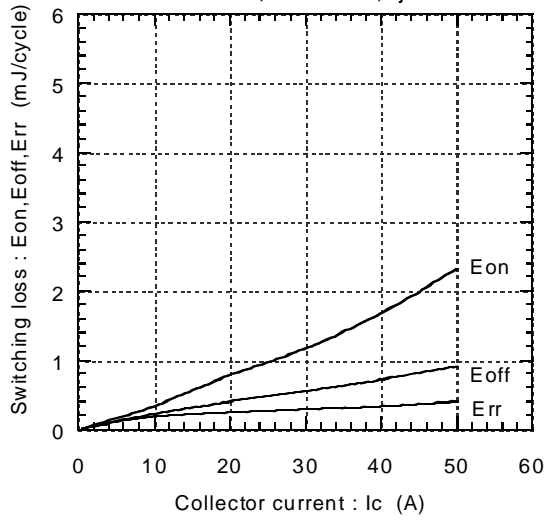

Switching Loss vs. Collector Current
 $E_{dc}=300V, V_{cc}=15V, T_j=125^\circ C$

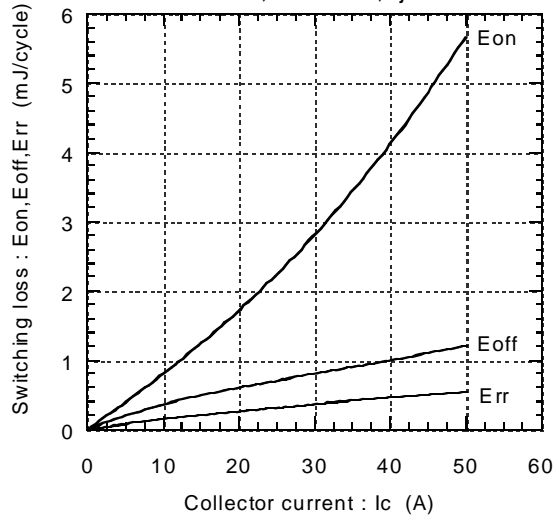

Reversed biased safe operating area
 $V_{cc}=15V, T_j \le 125^\circ C$

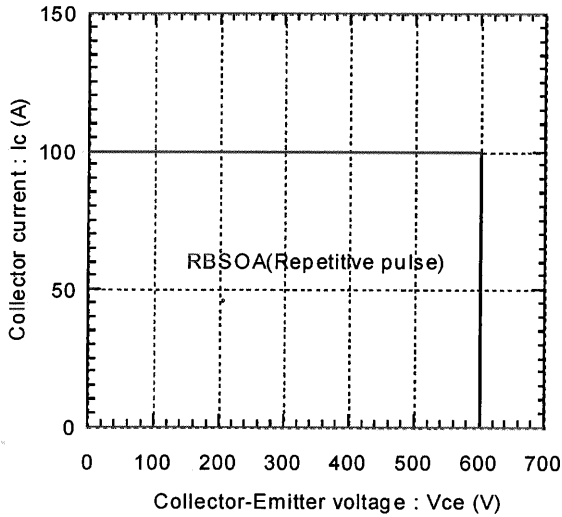

Transient thermal resistance

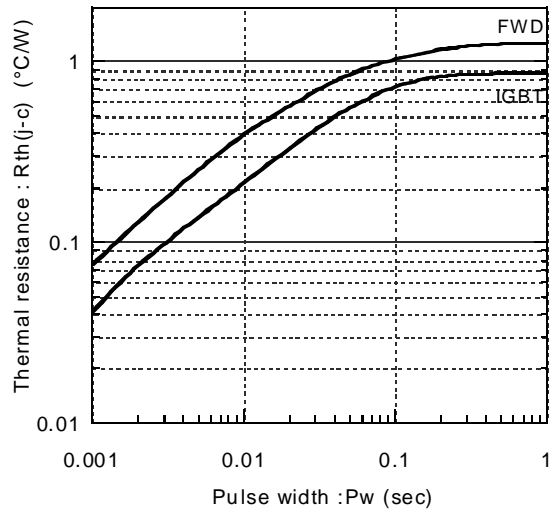

Power derating for IGBT
(per device)

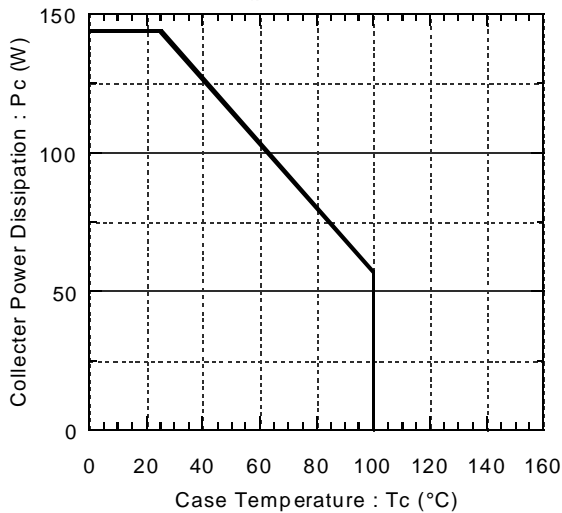

Power derating for FWD
(per device)

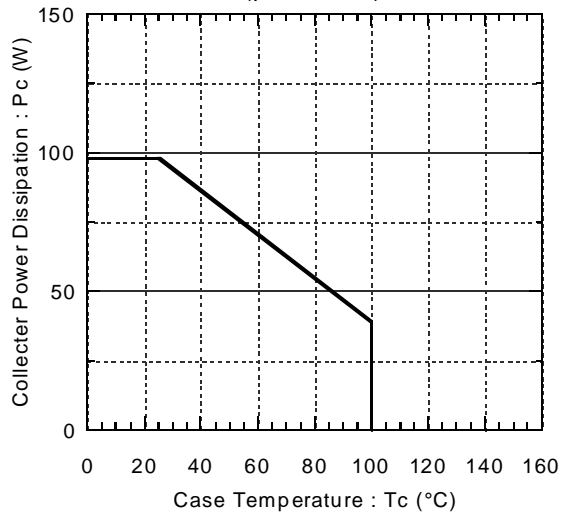

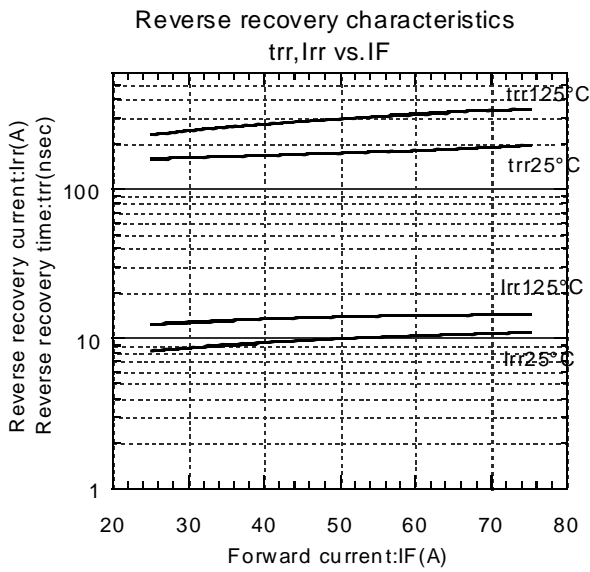
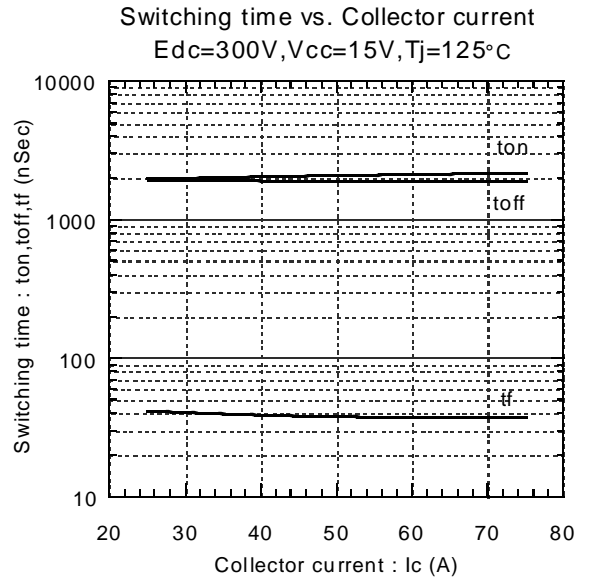
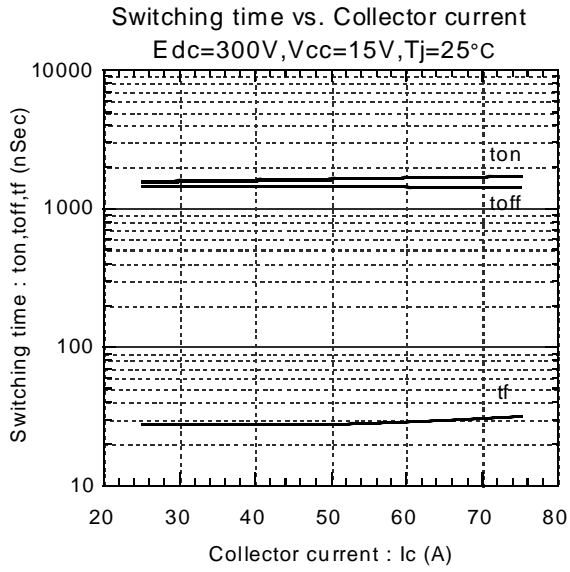

Characteristics

Dynamic Brake Characteristics (Representative)

Collector current vs. Collector-Emitter voltage
T_j=25°C

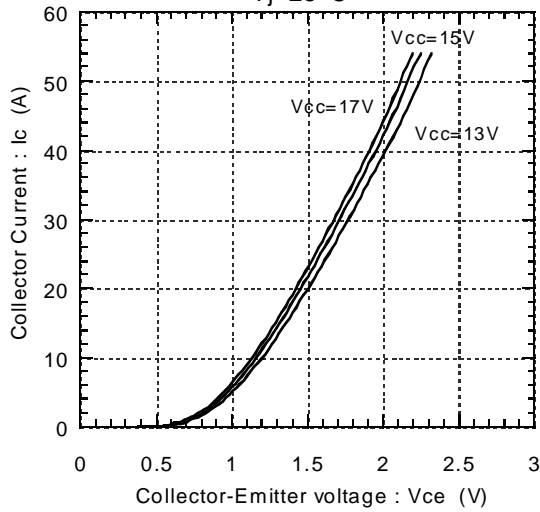

Collector current vs. Collector-Emitter voltage
T_j=125°C

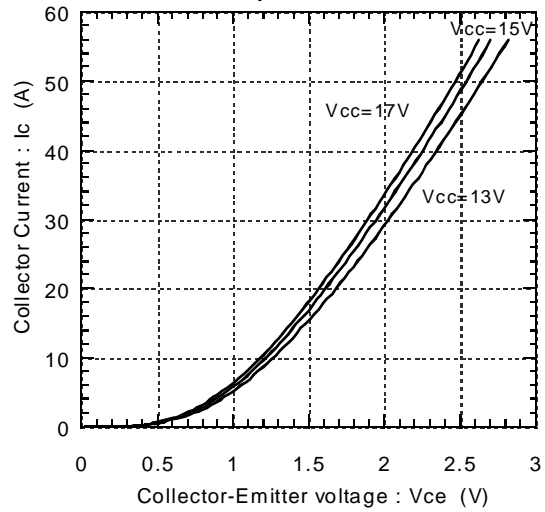

Transient thermal resistance

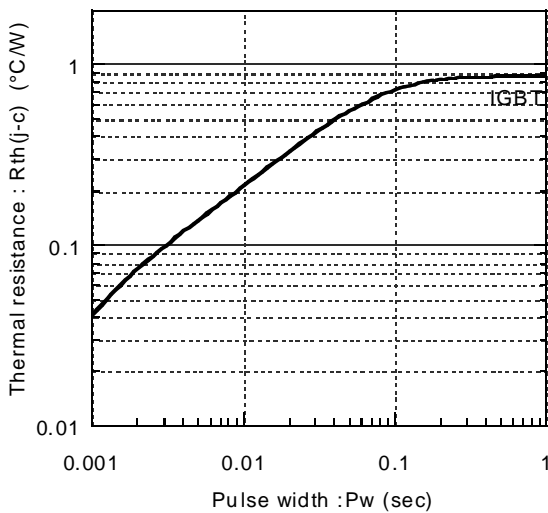

Reversed biased safe operating area
V_{cc}=15V, T_j ≤ 125°C

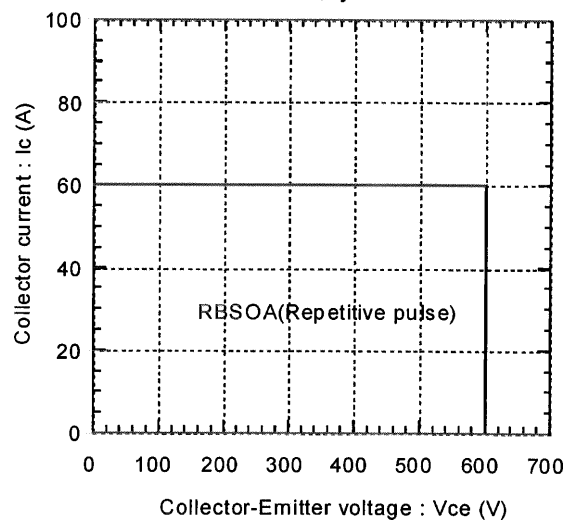

Power derating for IGBT
(per device)

