

7MBP50RA060

IGBT-IPM R series

600V / 50A 7 in one-package

Features

- Temperature protection provided by directly detecting the junction temperature of the IGBTs
- Low power loss and soft switching
- Compatible with existing IPM-N series packages
- High performance and high reliability IGBT with overheating protection
- Higher reliability because of a big decrease in number of parts in built-in control circuit

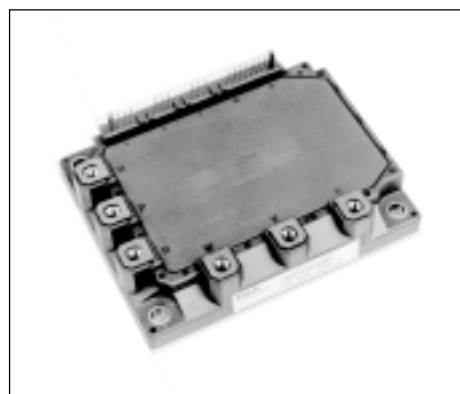

Maximum ratings and characteristics

- Absolute maximum ratings(at $T_c=25^{\circ}\text{C}$ unless otherwise specified)

Item	Symbol	Rating		Unit			
		Min.	Max.				
DC bus voltage	V_{DC}	0	450	V			
DC bus voltage (surge)	$V_{DC(surge)}$	0	500	V			
DC bus voltage (short operating)	V_{SC}	200	400	V			
Collector-Emitter voltage	V_{CES}	0	600	V			
DB Reverse voltage	V_R	0	600	V			
INV	Collector current	DC	I_c	-	50	A	
		1ms	I_{CP}	-	100	A	
		DC	$-I_c$	-	50	A	
DB	Collector power dissipation	One transistor	P_C	-	198	W	
		Collector current	DC	I_c	-	30	A
			1ms	I_{CP}	-	60	A
Forward current of Diode		I_F	-	30	A		
DB	Collector power dissipation	One transistor	P_C	-	120	W	
		Junction temperature		T_j	-	150	$^{\circ}\text{C}$
		Input voltage of power supply for Pre-Driver		V_{CC}^{*1}	0	20	V
Input signal voltage		V_{in}^{*2}	0	V_Z	V		
Input signal current		I_{in}	-	1	mA		
Alarm signal voltage		V_{ALM}^{*3}	0	V_{CC}	V		
Alarm signal current		I_{ALM}^{*4}	-	15	mA		
Storage temperature		T_{stg}	-40	125	$^{\circ}\text{C}$		
Operating case temperature		T_{op}	-20	100	$^{\circ}\text{C}$		
Isolating voltage (Case-Terminal)		V_{iso}^{*5}	-	AC2.5	kV		
Screw torque	Mounting (M5)		-	3.5^{*6}	N·m		
	Terminal (M5)		-	3.5^{*6}	N·m		

*1 Apply V_{CC} between terminal No. 3 and 1, 6 and 4, 9 and 7, 11 and 10.

*2 Apply V_{in} between terminal No. 2 and 1, 5 and 4, 8 and 7, 12,13,14,15 and 10.

*3 Apply V_{ALM} between terminal No. 16 and 10.

*4 Apply I_{ALM} to terminal No. 16.

*5 50Hz/60Hz sine wave 1 minute.

- Electrical characteristics of power circuit (at $T_c=T_j=25^{\circ}\text{C}$, $V_{CC}=15\text{V}$)

Item	Symbol	Condition	Min.	Typ.	Max.	Unit	
INV	Collector current at off signal input	I_{CES}	$V_{CE}=600\text{V}$ input terminal open	-	-	1.0	mA
	Collector-Emitter saturation voltage	$V_{CE(sat)}$	$I_c=50\text{A}$	-	-	2.8	V
	Forward voltage of FWD	V_F	$-I_c=50\text{A}$	-	-	3.0	V
DB	Collector current at off signal input	I_{CES}	$V_{CE}=600\text{V}$ input terminal open	-	-	1.0	mA
	Collector-Emitter saturation voltage	$V_{CE(sat)}$	$I_c=30\text{A}$	-	-	2.8	V
	Forward voltage of Diode	V_F	$-I_c=30\text{A}$	-	-	3.3	V

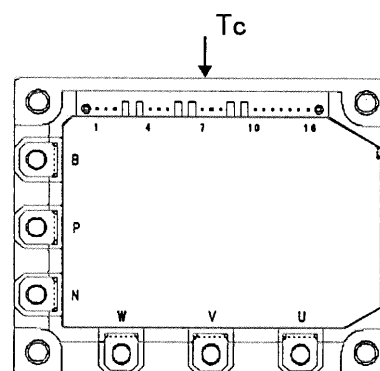

Fig.1 Measurement of case temperature

● Electrical characteristics of control circuit(at $T_c=T_j=25^\circ\text{C}$, $V_{cc}=15\text{V}$)

Item	Symbol	Condition	Min.	Typ.	Max.	Unit	
Power supply current of P-line side Pre-driver(one unit)	I_{ccp}	$f_{sw}=0$ to 15kHz $T_c=-20$ to 100°C *7	3	-	18	mA	
Power supply current of N-line side three Pre-driver	I_{ccn}	$f_{sw}=0$ to 15kHz $T_c=-20$ to 100°C *7	10	-	65	mA	
Input signal threshold voltage (on/off)	$V_{in(th)}$	ON	1.00	1.35	1.70	V	
		OFF	1.25	1.60	1.95	V	
Input zener voltage	V_z	$R_{in}=20\text{k ohm}$	-	8.0	-	V	
Over heating protection temperature level	T_{COH}	$V_{DC}=0\text{V}$, $I_c=0\text{A}$, Case temperature Fig.1	110	-	125	$^\circ\text{C}$	
Hysteresis	T_{CH}		-	20	-	$^\circ\text{C}$	
IGBT chips over heating protection temperature level	T_{JOH}	surface of IGBT chips	150	-	-	$^\circ\text{C}$	
Hysteresis	T_{JH}		-	20	-	$^\circ\text{C}$	
Collector current protection level	INV	I_{OC}	$T_j=125^\circ\text{C}$ Collector current	75	-	-	A
	DB	I_{OC}	$T_j=125^\circ\text{C}$ Collector current	45	-	-	A
Over current protection delay time	t_{DOC}	$T_j=25^\circ\text{C}$ Fig.2	-	10	-	μs	
Under voltage protection level	V_{UV}		11.0	-	12.5	V	
Hysteresis	V_H		0.2	-	-	V	
Alarm signal hold time	t_{ALM}		1.5	2	-	ms	
SC protection delay time	t_{SC}	$T_j=25^\circ\text{C}$ Fig.3	-	-	12	μs	
Limiting resistor for alarm	R_{ALM}		1425	1500	1575	ohm	

*7 Switching frequency of IPM

● Dynamic characteristics(at $T_c=T_j=125^\circ\text{C}$, $V_{cc}=15\text{V}$)

Item	Symbol	Condition	Min.	Typ.	Max.	Unit
Switching time (IGBT)	t_{on}	$I_C=50\text{A}$, $V_{DC}=300\text{V}$	0.3	-	-	μs
	t_{off}		-	-	3.6	μs
Switching time (FWD)	t_{rr}	$I_F=50\text{A}$, $V_{DC}=300\text{V}$	-	-	0.4	μs

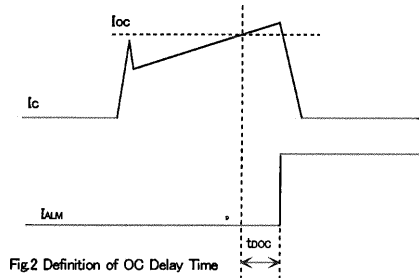

Fig2 Definition of OC Delay Time

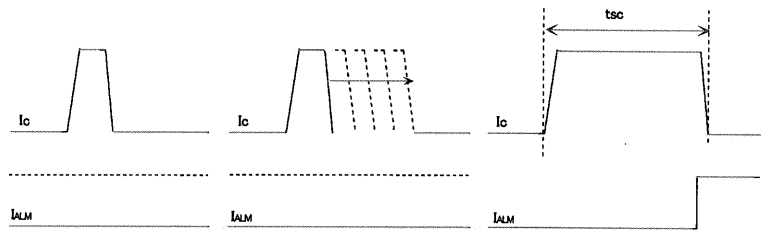

Fig3 Definition of tsc

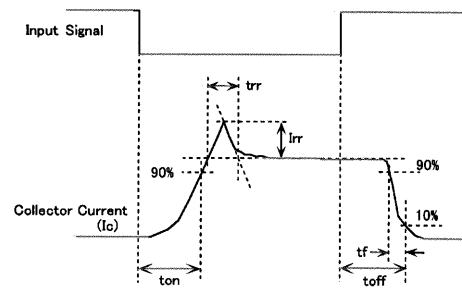

Fig4 Definition of Switching Time

● Thermal characteristics($T_c=25^\circ\text{C}$)

Item	Symbol	Typ.	Max.	Unit		
Junction to Case thermal resistance	INV	IGBT	$R_{th(j-c)}$	-	0.63	$^\circ\text{C/W}$
		FWD	$R_{th(j-c)}$	-	1.33	$^\circ\text{C/W}$
	DB	IGBT	$R_{th(j-c)}$	-	1.04	$^\circ\text{C/W}$
Case to fin thermal resistance with compound	$R_{th(c-f)}$	0.05	-	-	$^\circ\text{C/W}$	

● Recommendable value

Item	Symbol	Min.	Typ.	Max.	Unit	
DC bus voltage	V_{DC}	200	-	400	V	
Operating power supply voltage range of Pre-driver	V_{cc}	13.5	15	16.5	V	
Switching frequency of IPM	f_{sw}	1	-	20	kHz	
Screw torque	Mounting (M5)	-	2.5	-	3.0	N·m
	Terminal (M5)	-	2.5	-	3.0	N·m

Block diagram

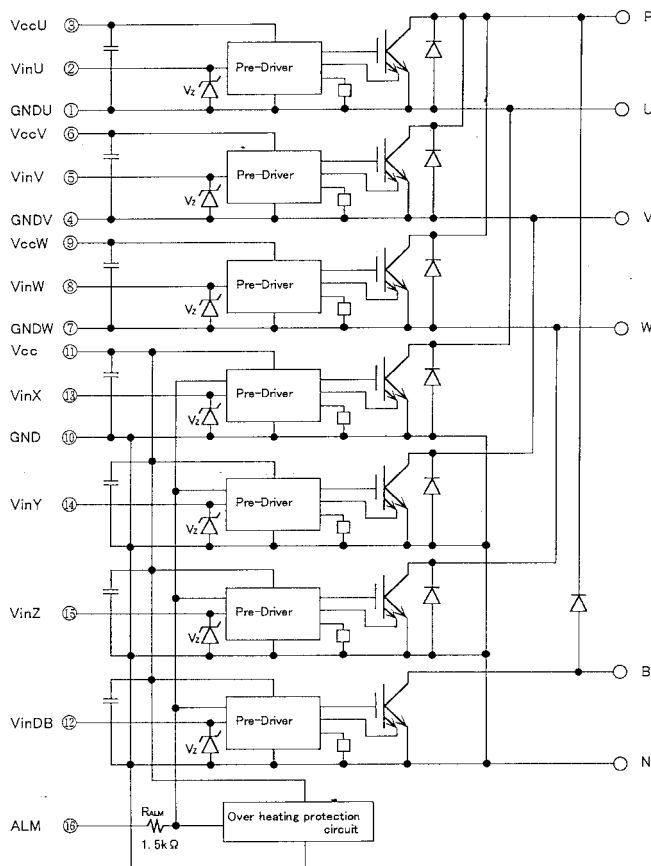

- Pre-drivers include following functions
- a) Short circuit protection circuit
 - b) Amplifier for driver
 - c) Undervoltage protection circuit
 - d) Over current protection circuit
 - e) IGBT chip over heating protection

Outline drawings, mm

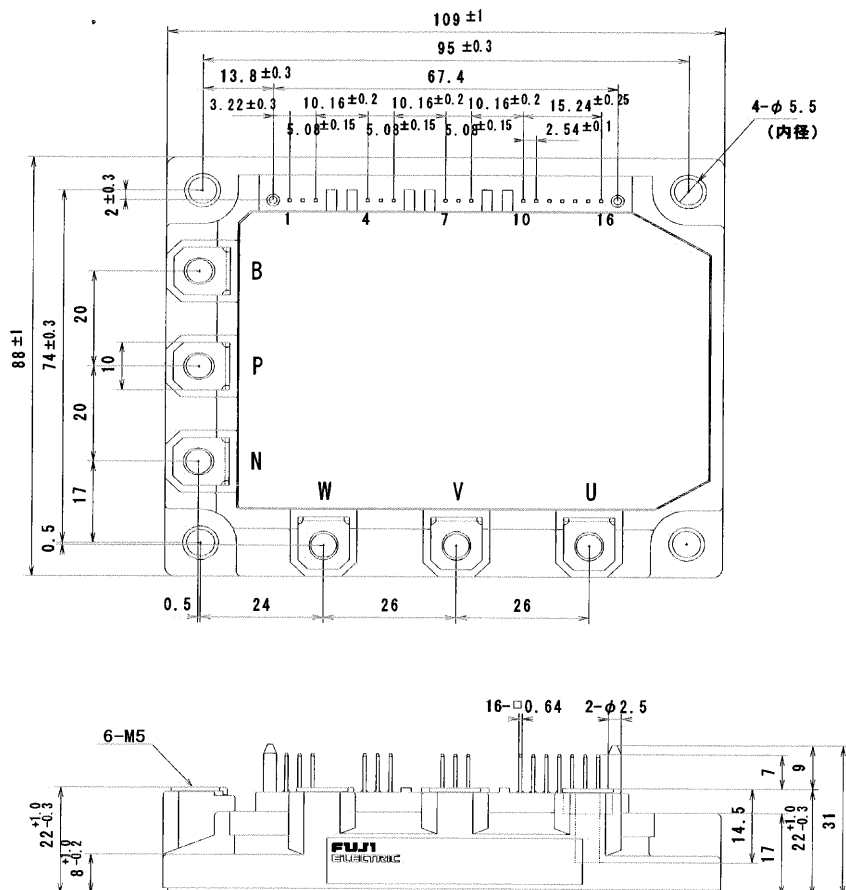

Mass : 440g

Characteristics (Representative)

Control Circuit

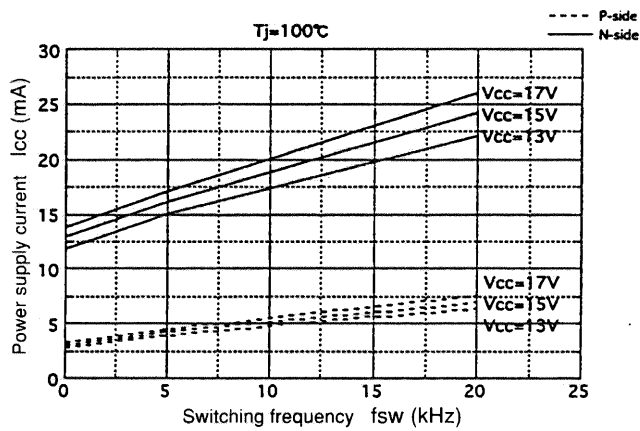

電源電流—スイッチング周波数特性
Power supply current vs. Switching frequency

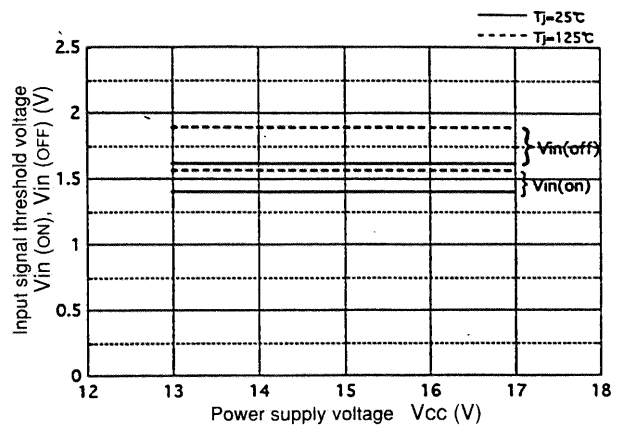

入力しきい値電圧—電源電圧特性
Input signal threshold voltage vs. Power supply voltage

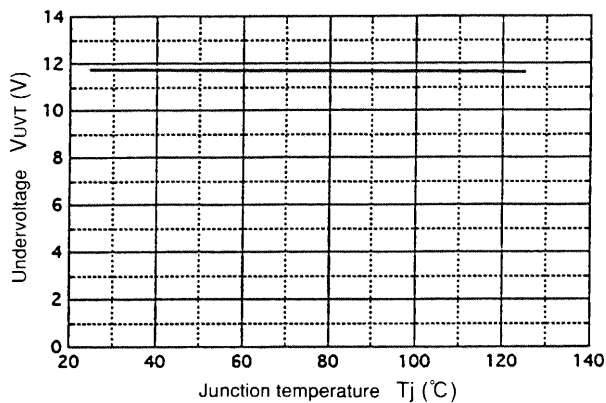

制御電源電圧低下保護レベル—接合部温度特性
Undervoltage vs. Junction temperature

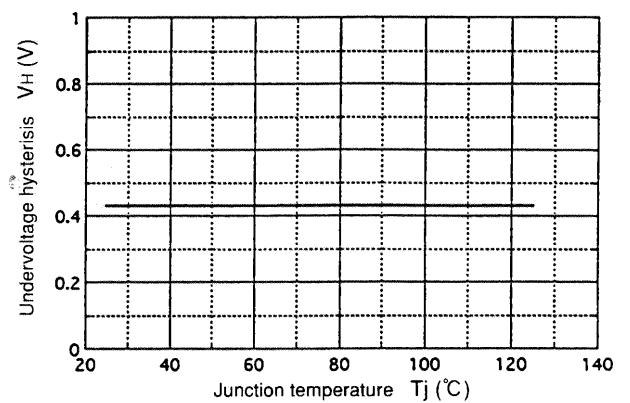

電圧低下保護ヒステリシス—接合部温度特性
Undervoltage hysteresis vs. Junction temperature

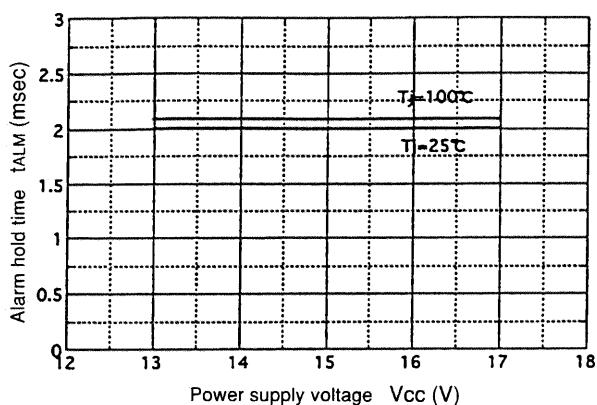

アラーム出力保持時間—電源電圧特性
Alarm hold time vs. Power supply voltage

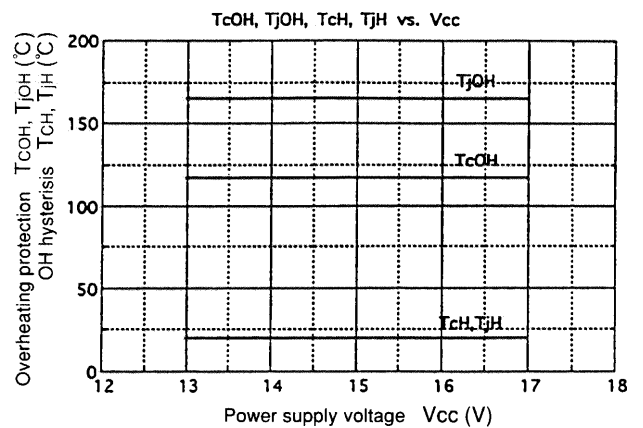

過熱保護動作温度—電源電圧特性
Overheating characteristics TcOH, TjOH, TcH, TjH vs. Vcc

● Inverter

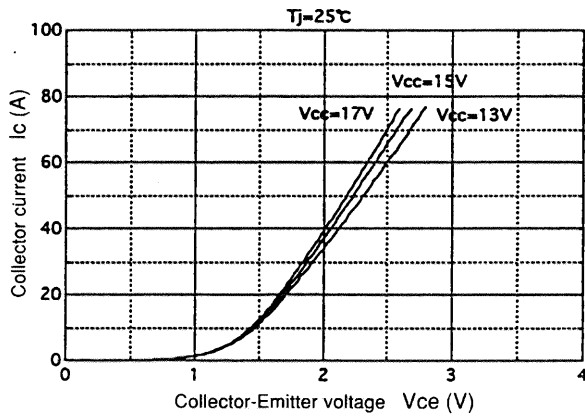

コレクタ電流—コレクタ・エミッタ間電圧特性
Collector current vs. Collector-Emitter voltage

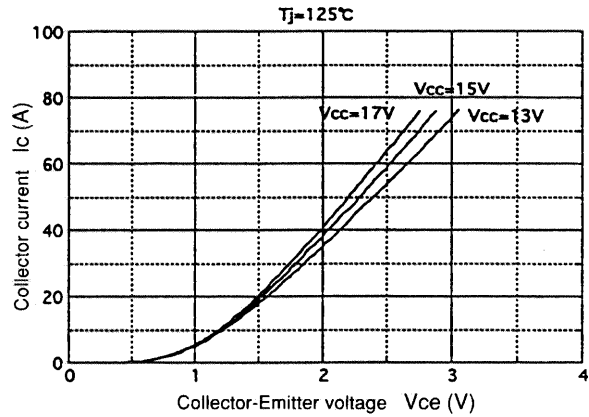

コレクタ電流—コレクタ・エミッタ間電圧特性
Collector current vs. Collector-Emitter voltage

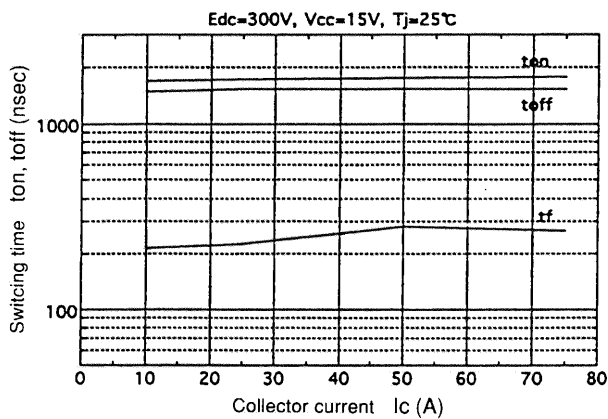

スイッチング時間—コレクタ電流特性
Switching time vs. Collector current

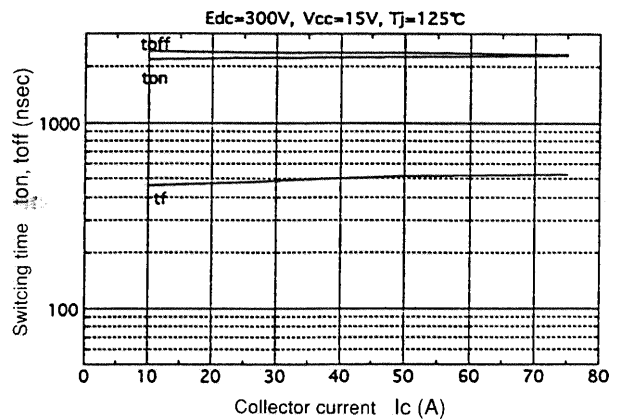

スイッチング時間—コレクタ電流特性
Switching time vs. Collector current

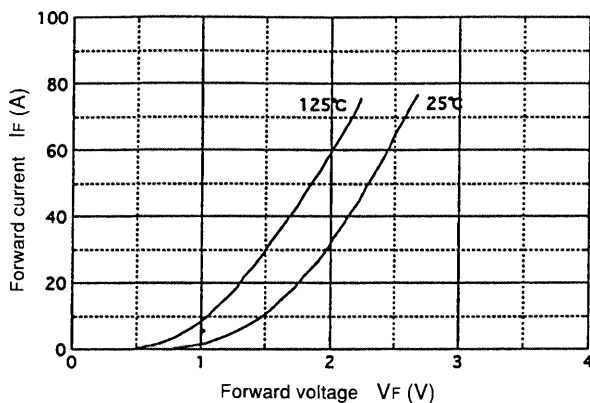

順電流—順電圧特性
Forward current vs. Forward voltage

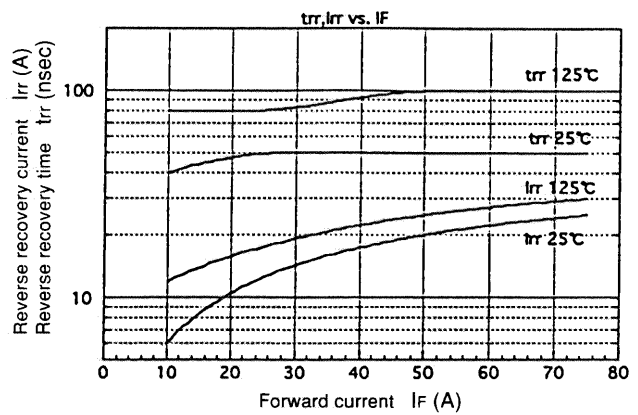

逆回復時間、逆回復電流—逆回復特性
Reverse recovery characteristics t_{rr} , I_{rr} vs. I_F

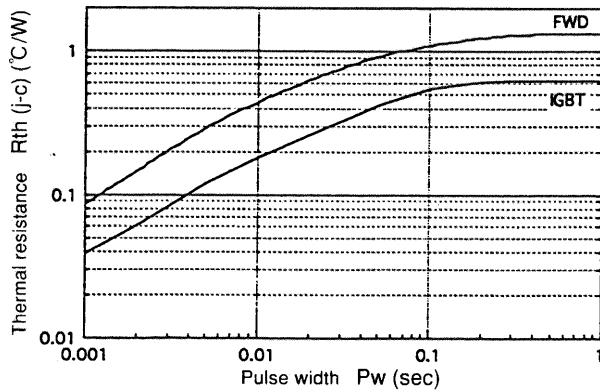

過渡熱抵抗特性
Transient thermal resistance

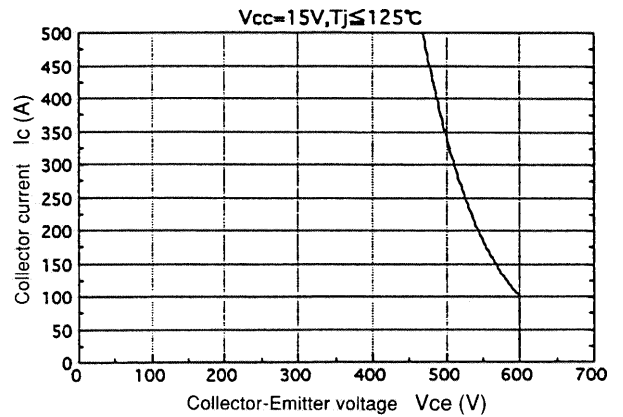

逆バイアス安全動作領域
Reverse biased safe operating area

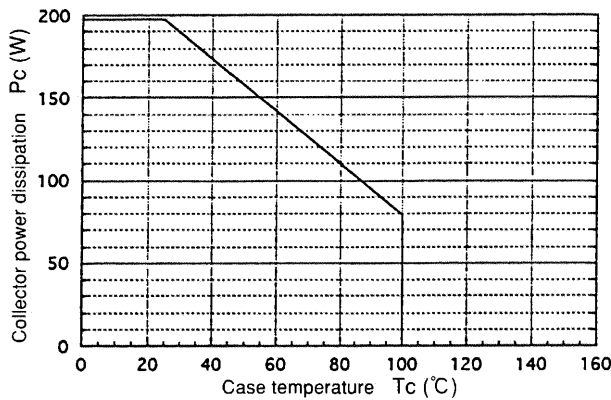

IGBT 電力低減特性 (1 チップ)
Power derating for IGBT (per device)

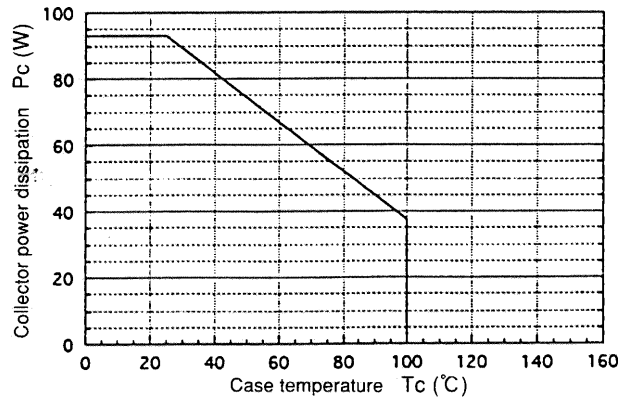

FWD 電力低減特性 (1 チップ)
Power derating for FWD (per device)

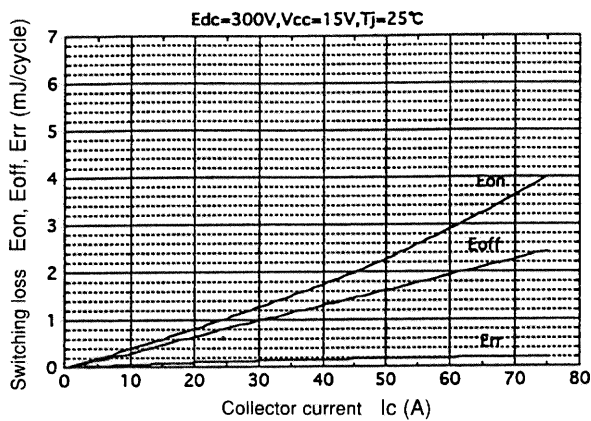

スイッチング損失—コレクタ電流特性
Switching loss vs. Collector current

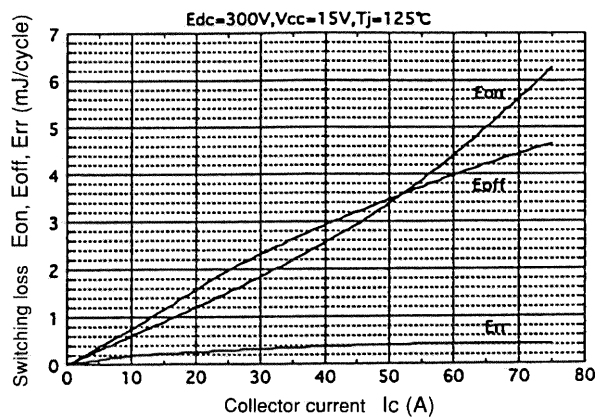

スイッチング損失—コレクタ電流特性
Switching loss vs. Collector current

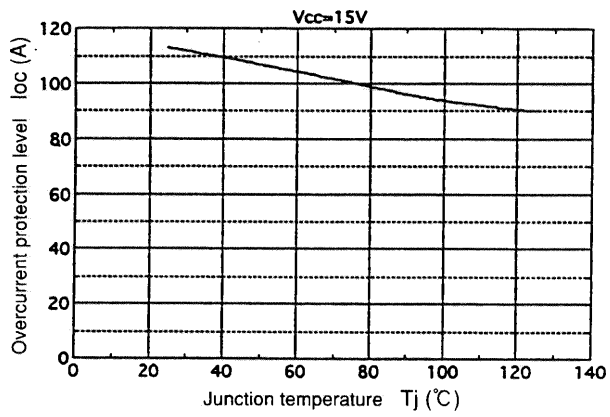

過電流保護—接合部温度特性

Overcurrent protection vs. Junction temperature

● Brake

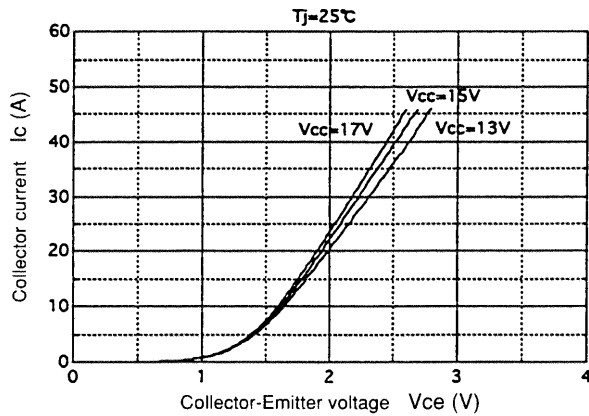

コレクタ電流—コレクタ・エミッタ間電圧特性
Collector current vs. Collector-Emitter voltage

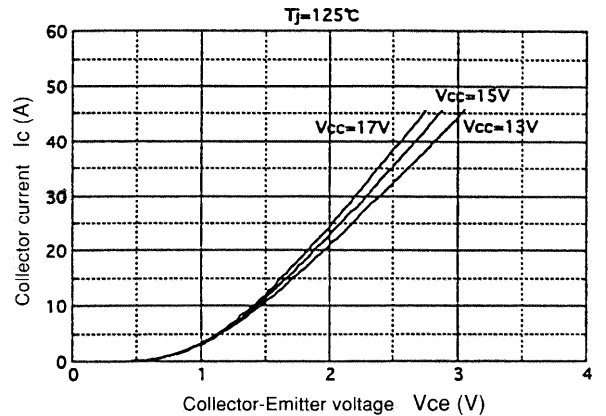

コレクタ電流—コレクタ・エミッタ間電圧特性
Collector current vs. Collector-Emitter voltage

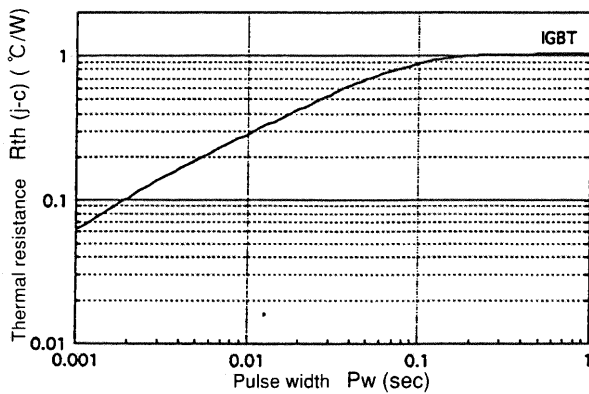

過渡熱抵抗特性
Transient thermal resistance

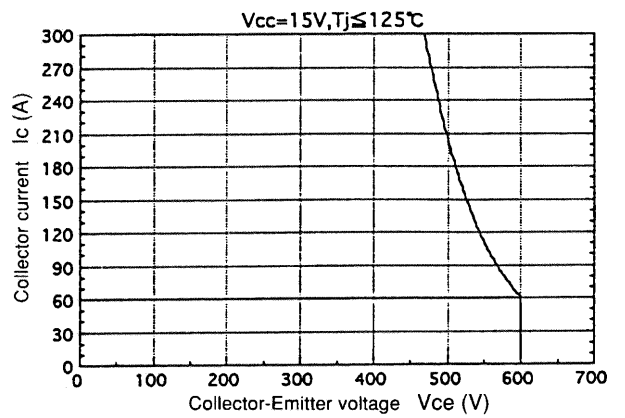

逆バイアス安全動作領域
Reverse biased safe operating area

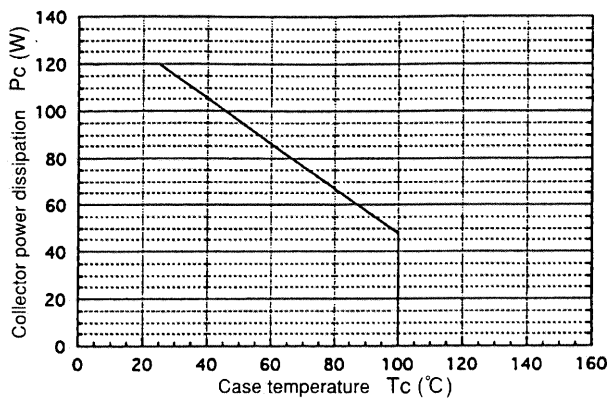

IGBT 電力低減特性
Power derating for IGBT(per device)

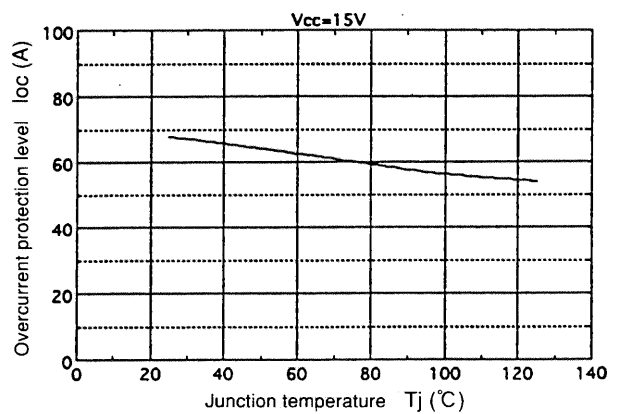

過電流保護—接合部温度特性
Overcurrent protection vs. Junction temperature