

6MBI75S-120

IGBT Modules

IGBT MODULE (S series) 1200V / 75A 6 in one-package

■ Features

- Compact package
- P.C.board mount
- Low $V_{CE(sat)}$

■ Applications

- Inverter for motor drive
- AC and DC servo drive amplifier
- Uninterruptible power supply
- Industrial machines, such as welding machines

■ Maximum ratings and characteristics

● Absolute maximum ratings ($T_c=25^\circ\text{C}$ unless otherwise specified)

| Item | Symbol | Rating | Unit | |
|-----------------------------------|-------------|------------------------|------------------|---|
| Collector-Emitter voltage | V_{CES} | 1200 | V | |
| Gate-Emitter voltage | V_{GES} | ± 20 | V | |
| Collector current | Continuous | $T_c=25^\circ\text{C}$ | 100 | A |
| | | $T_c=80^\circ\text{C}$ | 75 | |
| | 1ms | $T_c=25^\circ\text{C}$ | 200 | A |
| | | $T_c=80^\circ\text{C}$ | 150 | |
| | | -Ic | 75 | A |
| | 1ms | -Ic pulse | 150 | A |
| Max. power dissipation (1 device) | P_c | 520 | W | |
| Operating temperature | T_j | +150 | $^\circ\text{C}$ | |
| Storage temperature | T_{stg} | -40 to +125 | $^\circ\text{C}$ | |
| Isolation voltage | V_{is} | AC 2500 (1min.) | V | |
| Screw torque | Mounting *1 | 3.5 | N·m | |

*1 : Recommendable value : 2.5 to 3.5 N·m (M5)

● Electrical characteristics ($T_j=25^\circ\text{C}$ unless otherwise specified)

| Item | Symbol | Characteristics | | | Conditions | Unit | |
|--------------------------------------|---------------|-----------------|------|------|---|--|---|
| | | Min. | Typ. | Max. | | | |
| Zero gate voltage collector current | I_{CES} | - | - | 1.0 | $V_{GE}=0\text{V}$, $V_{CE}=1200\text{V}$ | mA | |
| Gate-Emitter leakage current | I_{GES} | - | - | 0.2 | $V_{CE}=0\text{V}$, $V_{GE}=\pm 20\text{V}$ | μA | |
| Gate-Emitter threshold voltage | $V_{GE(th)}$ | 5.5 | 7.2 | 8.5 | $V_{CE}=20\text{V}$, $I_c=75\text{mA}$ | V | |
| Collector-Emitter saturation voltage | $V_{CE(sat)}$ | - | 2.3 | 2.6 | $T_j=25^\circ\text{C}$ | $V_{GE}=15\text{V}$, $I_c=75\text{A}$ | V |
| | | - | 2.8 | - | $T_j=125^\circ\text{C}$ | | |
| Input capacitance | C_{ies} | - | 9000 | - | $V_{GE}=0\text{V}$ | pF | |
| Output capacitance | C_{oes} | - | 1875 | - | $V_{CE}=10\text{V}$ | | |
| Reverse transfer capacitance | C_{res} | - | 1650 | - | $f=1\text{MHz}$ | | |
| Turn-on time | t_{on} | - | 0.35 | 1.2 | $V_{CC}=600\text{V}$ $I_c=75\text{A}$ $V_{GE}=\pm 15\text{V}$ $R_G=16\Omega$ | μs | |
| | t_r | - | 0.25 | 0.6 | | | |
| | $t_{r(i)}$ | - | 0.1 | - | | | |
| Turn-off time | t_{off} | - | 0.45 | 1.0 | | | |
| | t_f | - | 0.08 | 0.3 | | | |
| Diode forward on voltage | V_F | - | 2.5 | 3.3 | $T_j=25^\circ\text{C}$ | $I_F=75\text{A}$, $V_{GE}=0\text{V}$ | V |
| | | - | 2.0 | - | $T_j=125^\circ\text{C}$ | | |
| Reverse recovery time | t_{rr} | - | - | 0.35 | $I_F=75\text{A}$ | μs | |

● Thermal resistance characteristics

| Item | Symbol | Characteristics | | | Conditions | Unit |
|--------------------|-----------------|-----------------|------|------|-------------------------|--------------------|
| | | Min. | Typ. | Max. | | |
| Thermal resistance | $R_{th(j-c)}$ | - | - | 0.24 | IGBT | $^\circ\text{C/W}$ |
| | $R_{th(j-c)}$ | - | - | 0.50 | FWD | $^\circ\text{C/W}$ |
| | $R_{th(c-f)*2}$ | - | 0.05 | - | the base to cooling fin | $^\circ\text{C/W}$ |

*2 : This is the value which is defined mounting on the additional cooling fin with thermal compound



■ Equivalent Circuit Schematic

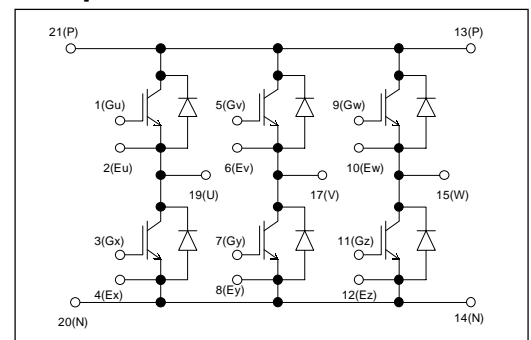

■ Characteristics

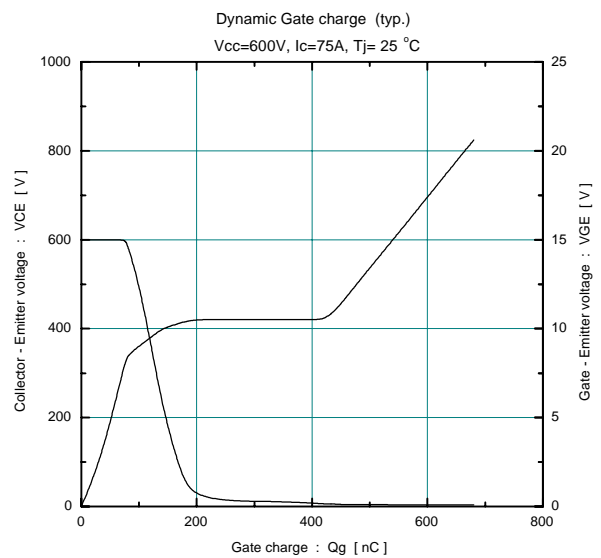
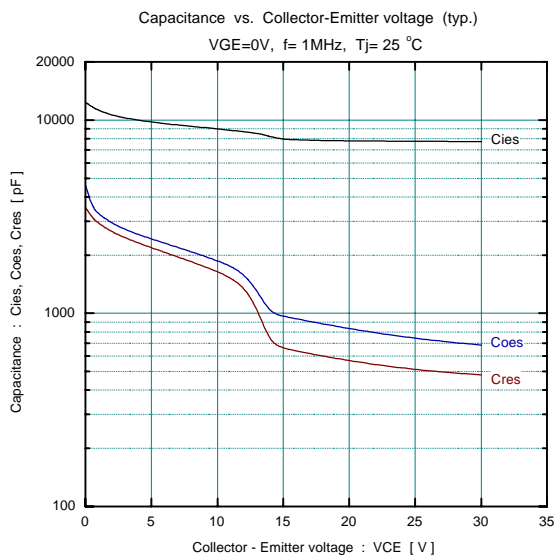
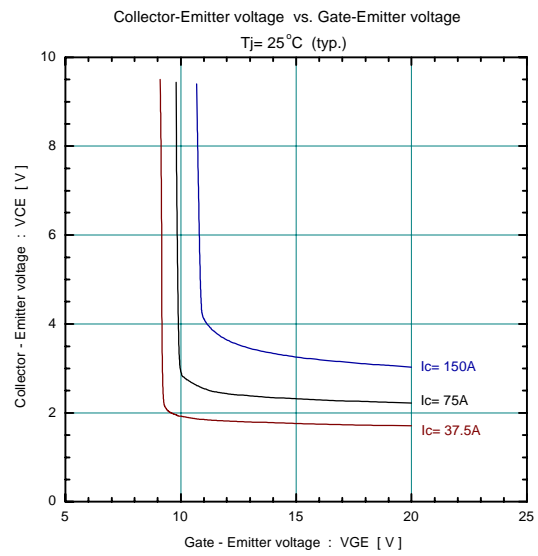
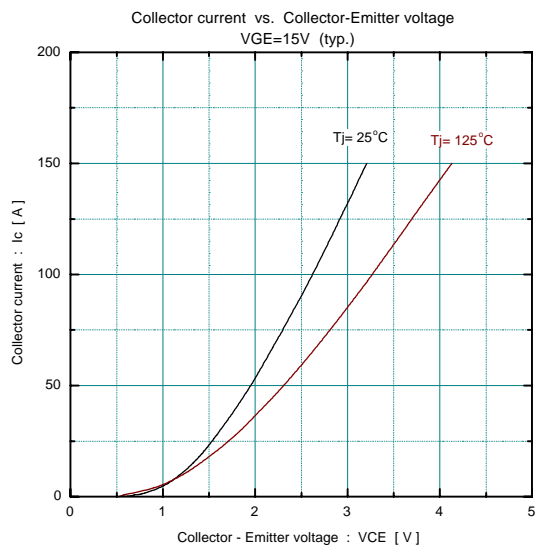
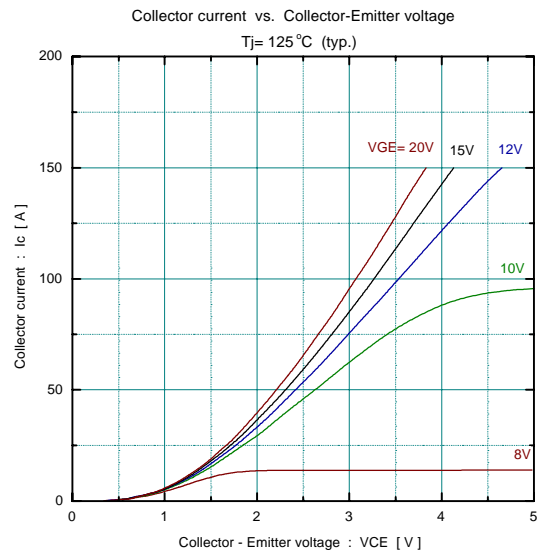
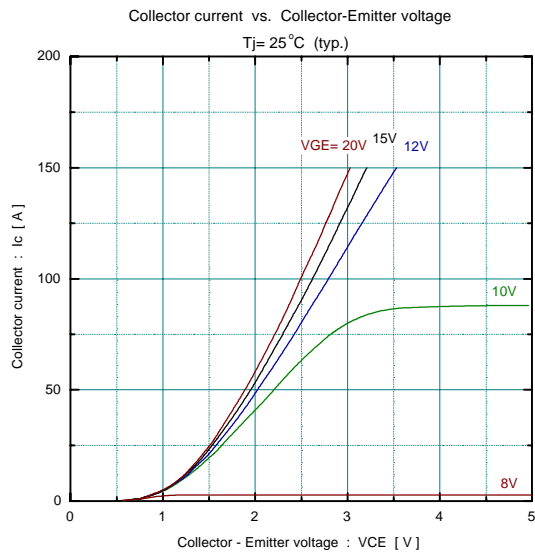

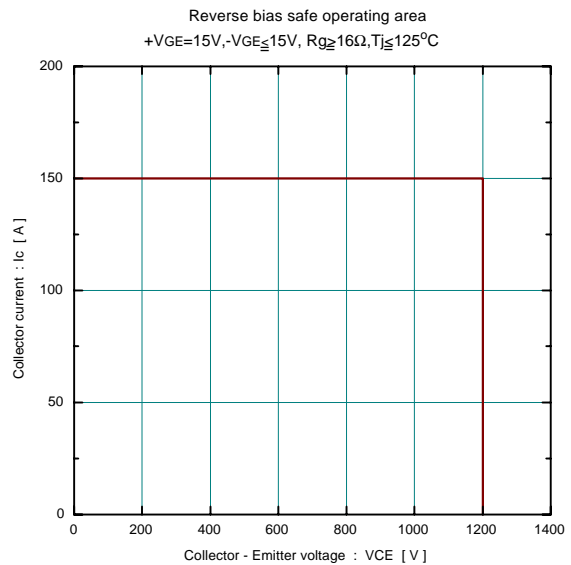
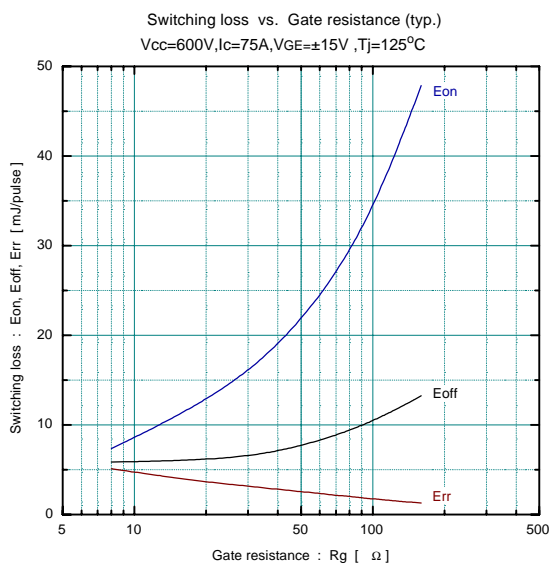
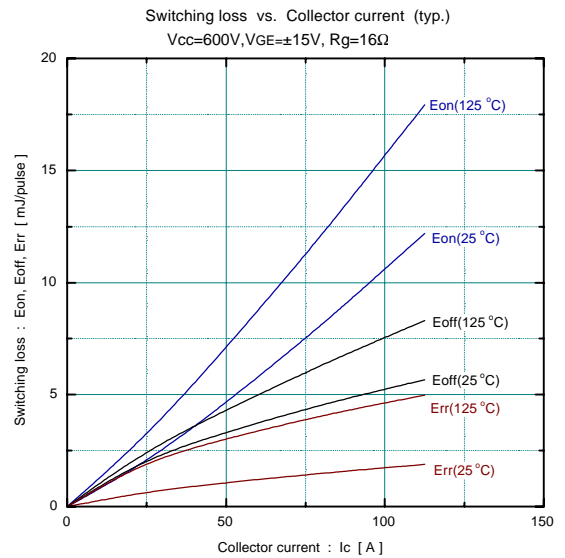
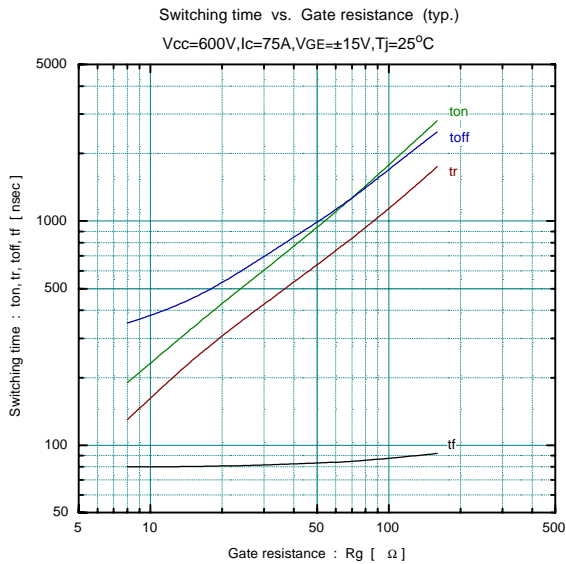
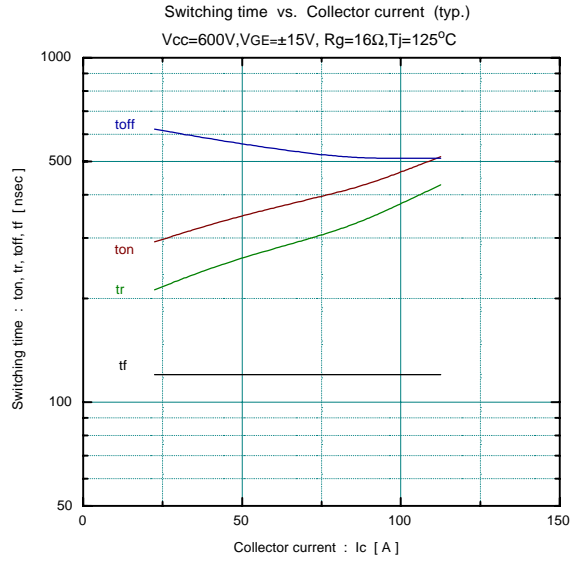
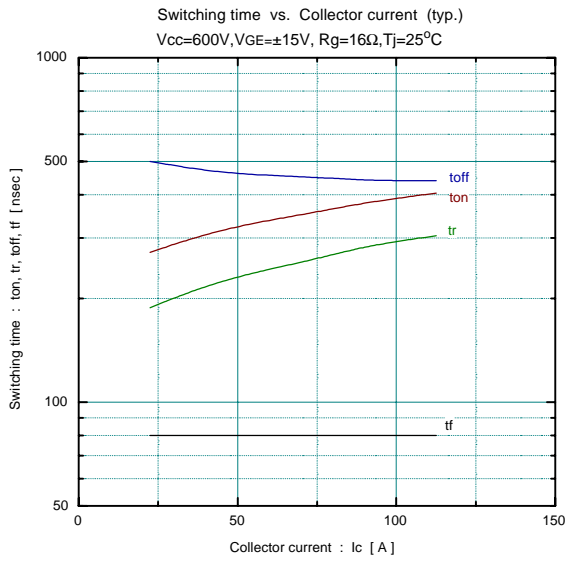

Forward current vs. Forward on voltage (typ.)

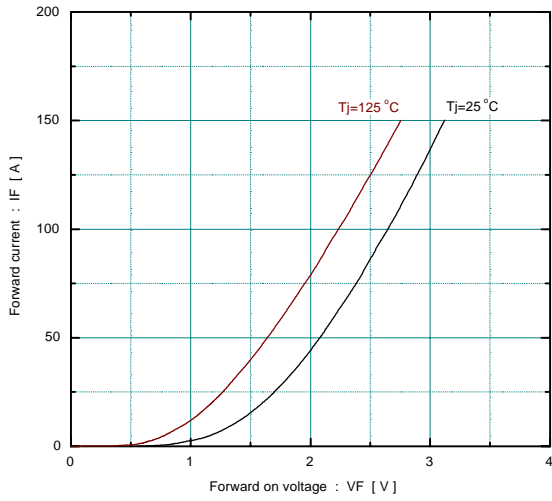

Reverse recovery characteristics (typ.)

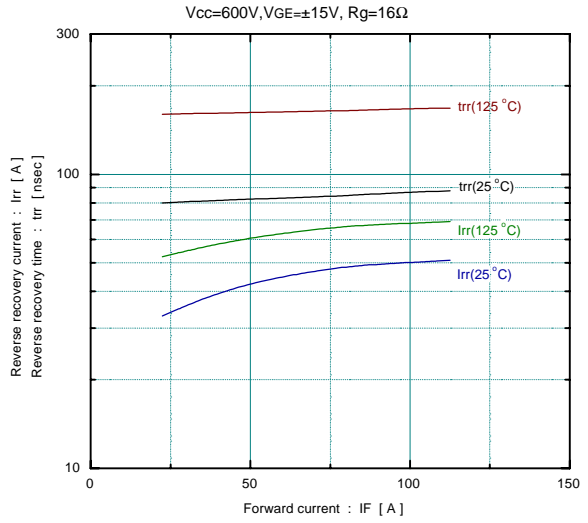

Transient thermal resistance

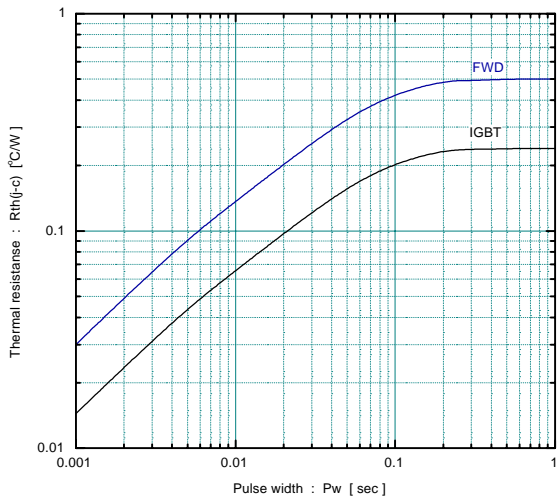

■ Outline Drawings, mm

