

IGBT MODULE (P-Series)

■ Features

- Square SC SOA at $10 \times I_C$
- Simplified Parallel Connection
- Narrow Distribution of Characteristics
- High Short Circuit Withstand-Capability

■ Applications

- High Power Switching
- A.C. Motor Controls
- D.C. Motor Controls
- Uninterruptible Power Supply

■ Outline Drawing

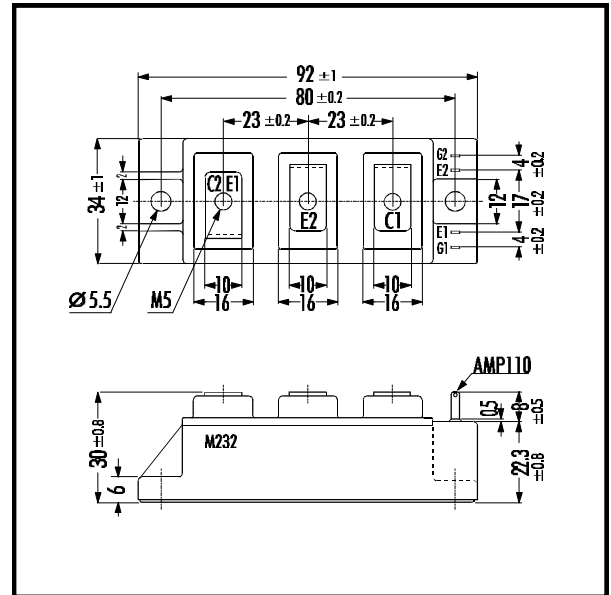

■ Maximum Ratings and Characteristics

• Absolute Maximum Ratings ($T_c=25^\circ\text{C}$)

Items	Symbols	Ratings	Units
Collector-Emitter Voltage	V_{CES}	1400	V
Gate -Emitter Voltage	V_{GES}	± 20	V
Collector Current	Continuous $T_c=25^\circ\text{C}$	75	A
		50	
	1ms $T_c=25^\circ\text{C}$	150	
		1ms $T_c=80^\circ\text{C}$	
	1ms	$-I_C$	
Max. Power Dissipation	P_C	400	W
Operating Temperature	T_j	+150	$^\circ\text{C}$
Storage Temperature	T_{stg}	-40 ~ +125	$^\circ\text{C}$
Isolation Voltage	A.C. 1min. V_{is}	2500	V
Screw Torque	Mounting *1	3.5	Nm
	Terminals *2	3.5	

Note: *1:Recommendable Value; 2.5 - 3.5 Nm (M5)

■ Equivalent Circuit

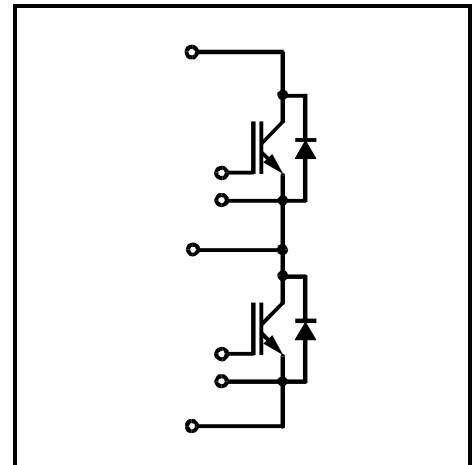

• Electrical Characteristics (at $T_f=25^\circ\text{C}$)

Items	Symbols	Test Conditions	Min.	Typ.	Max.	Units
Zero Gate Voltage Collector Current	I_{CES}	$V_{GE}=0V$ $V_{CE}=1400V$			1.0	mA
Gate-Emitter Leakage Current	I_{GES}	$V_{CE}=0V$ $V_{GE}=\pm 20V$			200	μA
Gate-Emitter Threshold Voltage	$V_{GE(th)}$	$V_{GE}=20V$ $I_C=50\text{mA}$	6.0	8.0	9.0	V
Collector-Emitter Saturation Voltage	$V_{CE(sat)}$	$T_f=25^\circ\text{C}$ $V_{GE}=15V$ $I_C=50\text{A}$		2.7	3.0	V
		$T_f=125^\circ\text{C}$ $V_{GE}=15V$ $I_C=50\text{A}$		3.3		
Input capacitance	C_{ies}	$V_{CE}=0V$		5000		pF
Output capacitance	C_{oes}	$V_{CE}=10V$		750		
Reverse Transfer capacitance	C_{res}	$f=1\text{MHz}$		330		
Turn-on Time	t_{ON}	$V_{CC}=600V$			1.2	μs
	t_r	$I_C=50\text{A}$			0.6	
Turn-off Time	t_{OFF}	$V_{GE}=\pm 15V$			1.0	
	t_f	$R_G=2,4\Omega$			0.3	
Diode Forward On-Voltage	V_F	$I_F=50\text{A}$ $V_{GE}=0V$		2.4	3.3	V
Reverse Recovery Time	t_{rr}	$I_F=50\text{A}$			350	ns

• Thermal Characteristics

Items	Symbols	Test Conditions	Min.	Typ.	Max.	Units
Thermal Resistance	$R_{th(f-c)}$	IGBT			0.31	$^\circ\text{C/W}$
	$R_{th(f-c)}$	Diode			0.66	
	$R_{th(c-f)}$	With Thermal Compound		0.05		

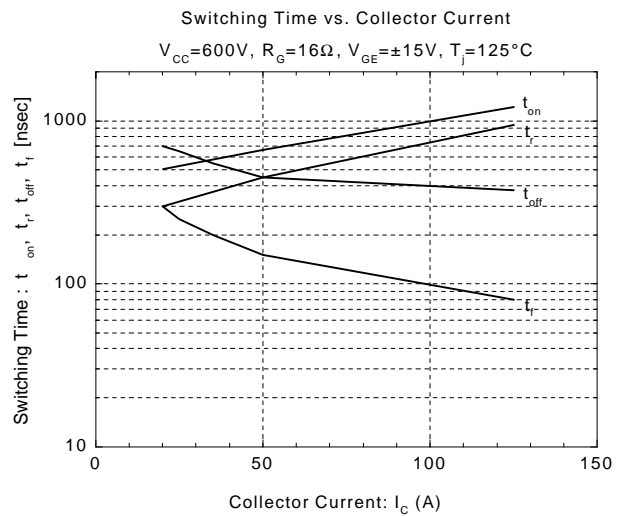
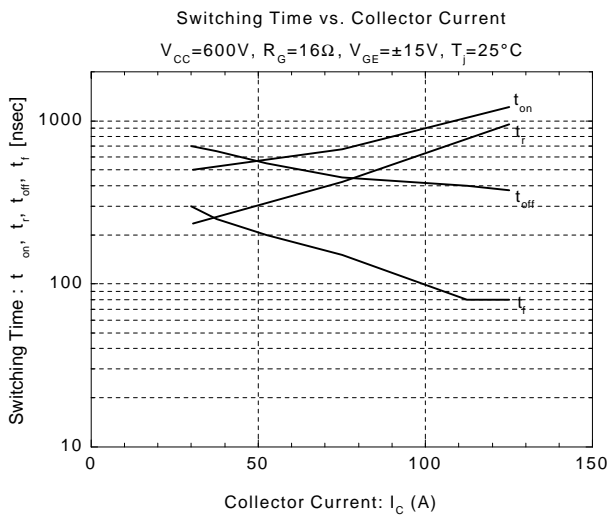
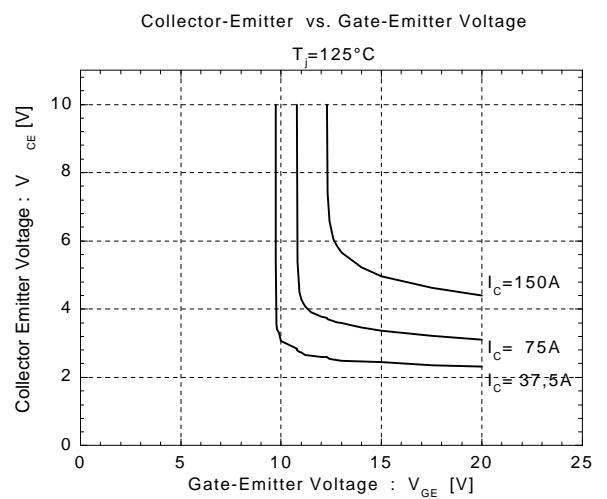
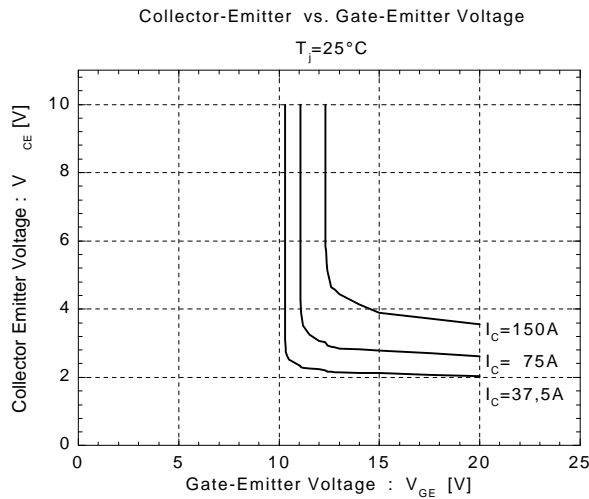
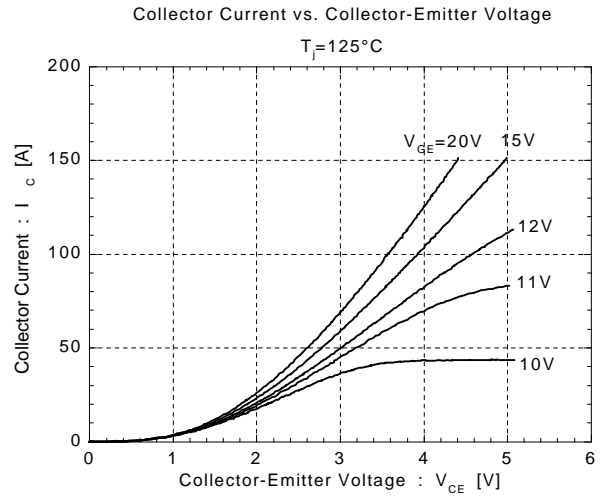
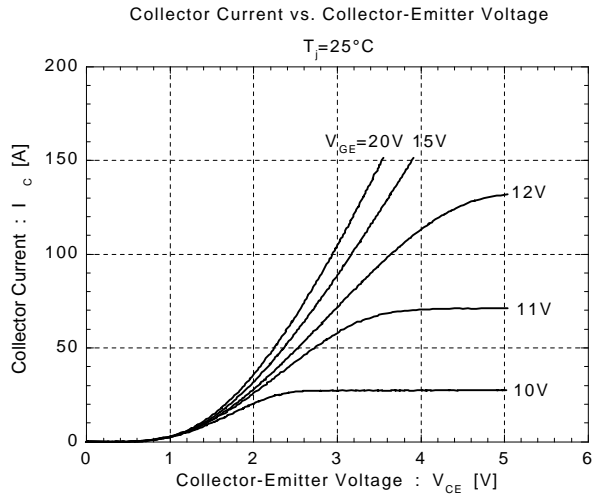

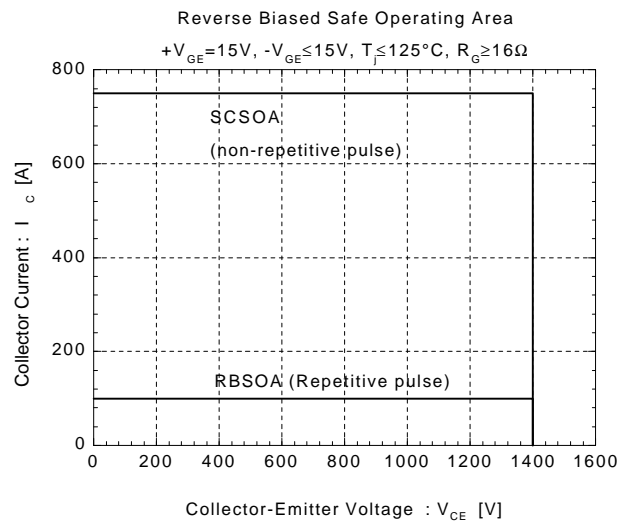
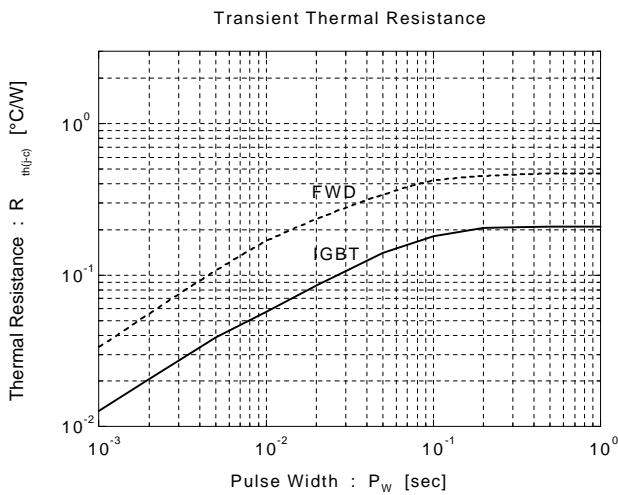
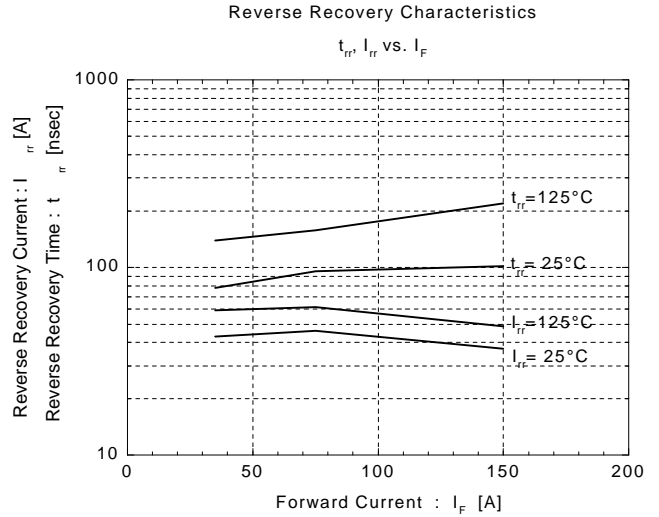
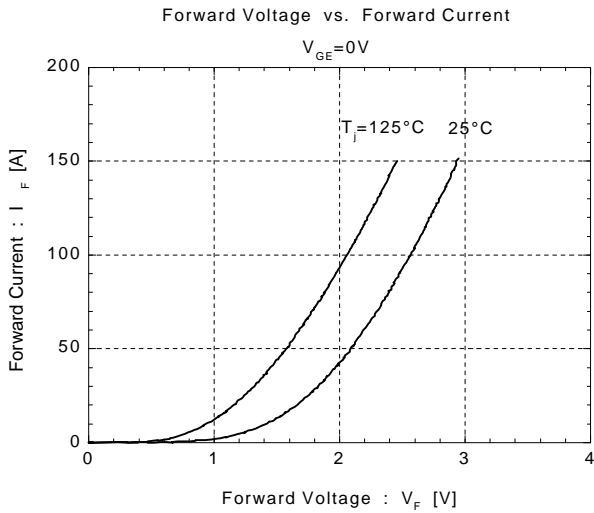
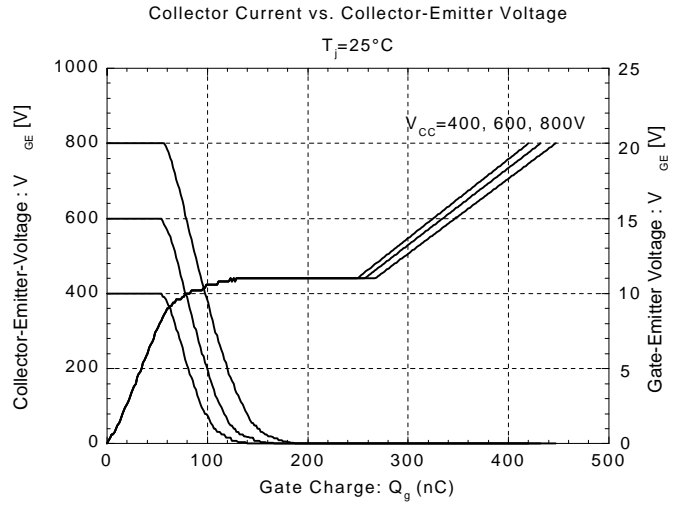
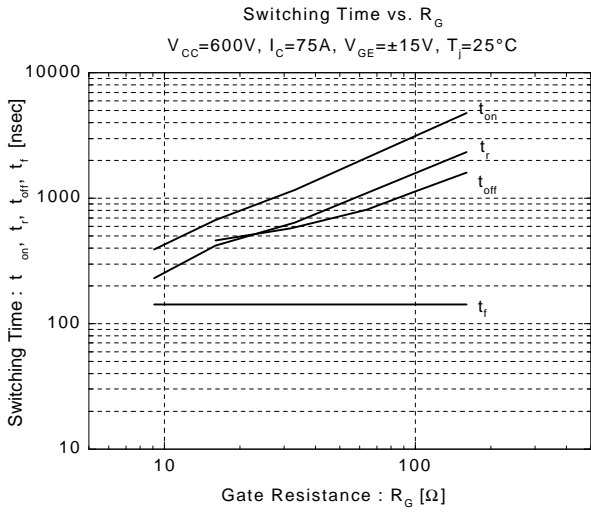

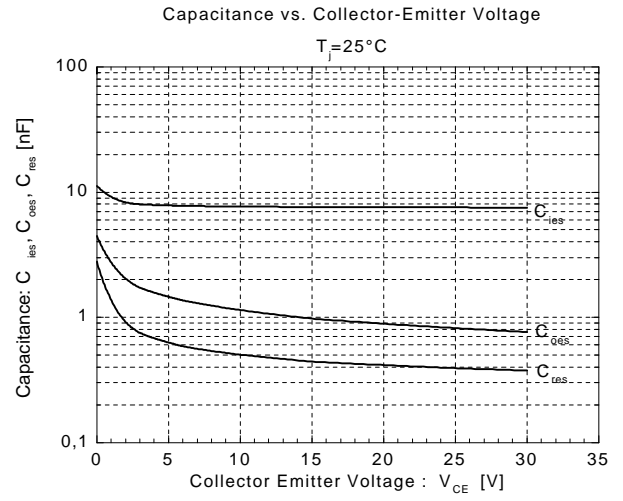
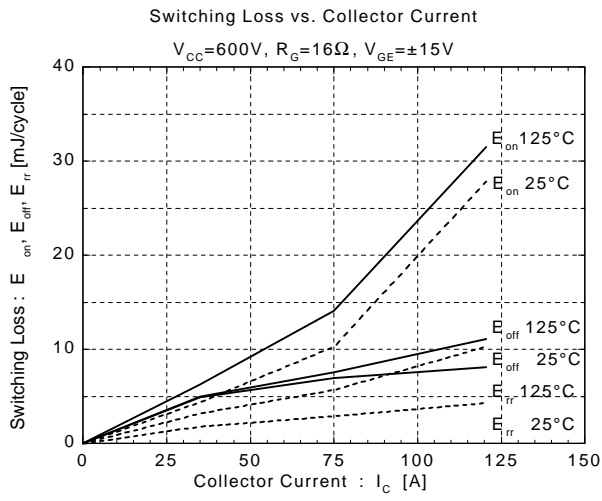

For more information, contact:

Collmer Semiconductor, Inc.

P.O. Box 702708

Dallas, TX 75370

972-233-1589

972-233-0481 Fax

<http://www.collmer.com>