

2MBI600NT-060

IGBT Module

600V / 600A 2 in one-package

■ Features

- VCE(sat) classified for easy parallel connection
- High speed switching
- Voltage drive
- Low inductance module structure

■ Applications

- Inverter for Motor drive
- AC and DC Servo drive amplifier
- Uninterruptible power supply
- Industrial machines, such as Welding machines

■ Maximum ratings and characteristics

● Absolute maximum ratings (at Tc=25°C unless otherwise specified)

Item	Symbol	Rating	Unit
Collector-Emitter voltage	V _{CES}	600	V
Gate-Emitter voltage	V _{GES}	±20	V
Collector current	Continuous	I _C	600
	1ms	I _C pulse	1200
		-I _C	600
	1ms	-I _C pulse	1200
Max. power dissipation	P _C	2500	W
Operating temperature	T _j	+150	°C
Storage temperature	T _{stg}	-40 to +125	°C
Isolation voltage	V _{is}	AC 2500 (1min.)	V
Screw torque	Mounting *1	3.5	N·m
	Terminals *2	4.5	N·m

*1 : Recommendable value : 2.5 to 3.5N·m (M5) or (M6)

*2 : Recommendable value : 3.5 to 4.5N·m (M6)

● Electrical characteristics (at Tj=25°C unless otherwise specified)

Item	Symbol	Characteristics			Conditions	Unit
		Min.	Typ.	Max.		
Zero gate voltage collector current	I _{CES}	–	–	4.0	V _{GE} =0V, V _{CES} =600V	mA
Gate-Emitter leakage current	I _{GES}	–	–	60	V _{CES} =0V, V _{GES} =±20V	µA
Gate-Emitter threshold voltage	V _{GE(th)}	4.5	–	7.5	V _{CES} =20V, I _C =600mA	V
Collector-Emitter saturation voltage	V _{CES(sat)}	–	–	2.9	V _{GE} =15V, I _C =600A	V
Input capacitance	C _{ies}	–	39600	–	V _{GE} =0V	pF
Output capacitance	C _{oes}	–	8800	–	V _{CES} =10V	
Reverse transfer capacitance	C _{res}	–	2670	–	f=1MHz	
Turn-on time	t _{on}	–	0.6	1.2	V _{CC} =300V	µs
	t _r	–	0.2	0.6	I _C =600A	
Turn-off time	t _{off}	–	0.6	1.0	V _{GE} =±15V	µs
	t _f	–	0.2	0.35	R _G =2.7ohm	
Diode forward on voltage	V _F	–	–	3.1	I _F =600A, V _{GE} =0V	V
Reverse recovery time	t _{rr}	–	–	0.3	I _F =600A	µs

● Thermal resistance characteristics

Item	Symbol	Characteristics			Conditions	Unit
		Min.	Typ.	Max.		
Thermal resistance	R _{th(j-c)}	–	–	0.05	IGBT	°C/W
	R _{th(j-c)}	–	–	0.1	Diode	°C/W
	R _{th(c-f)*}	–	0.0167	–	the base to cooling fin	°C/W

* : This is the value which is defined mounting on the additional cooling fin with thermal compound



■ Equivalent Circuit Schematic

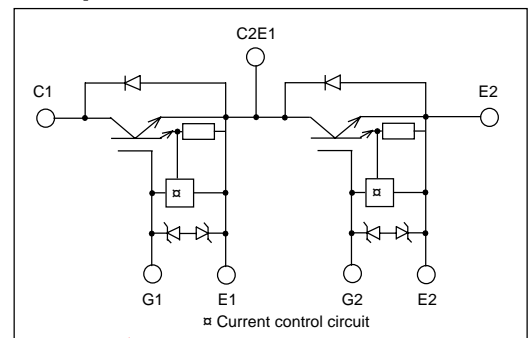

■ Characteristics (Representative)

Collector current vs. Collector-Emitter voltage
T_J=25°C

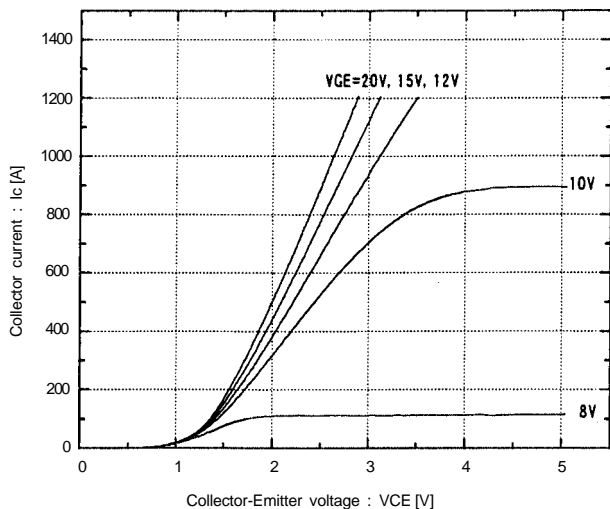

Collector current vs. Collector-Emitter voltage
T_J=125°C

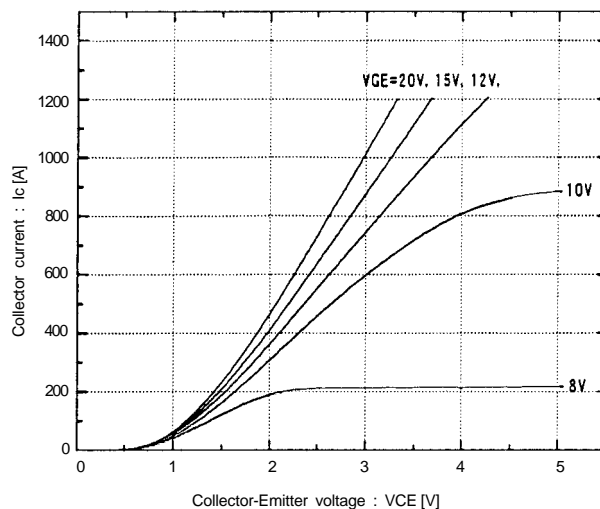

Collector-Emitter vs. Gate-Emitter voltage
T_J=25°C

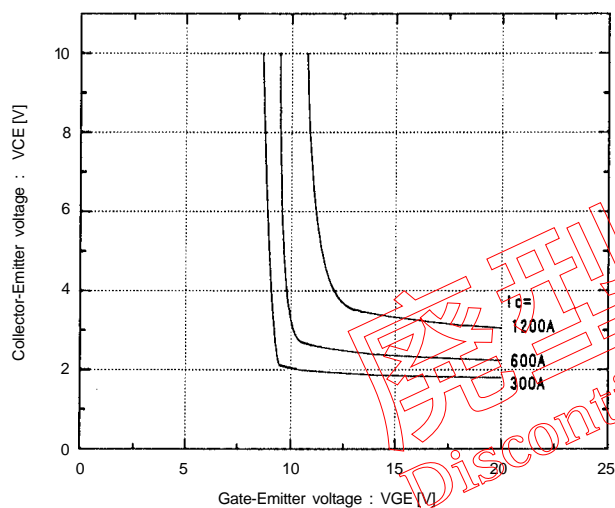

Collector-Emitter vs. Gate-Emitter voltage
T_J=125°C

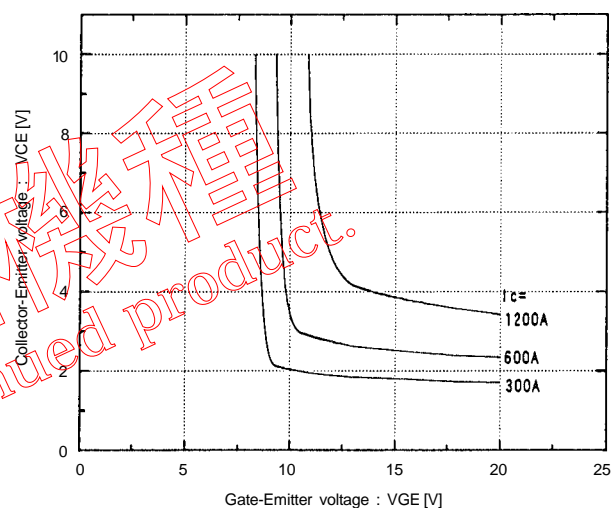

Switching time vs. Collector current
V_{CC}=300V, R_G=2.7 ohm, V_{GE}=±15V, T_J=25°C

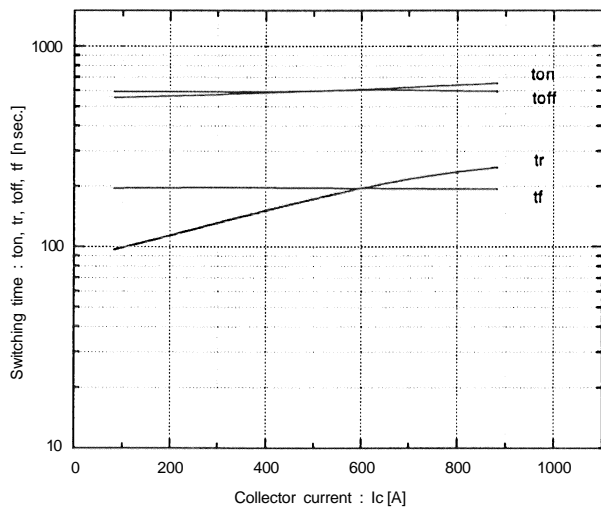

Switching time vs. Collector current
V_{CC}=300V, R_G=2.7 ohm, V_{GE}=±15V, T_J=125°C

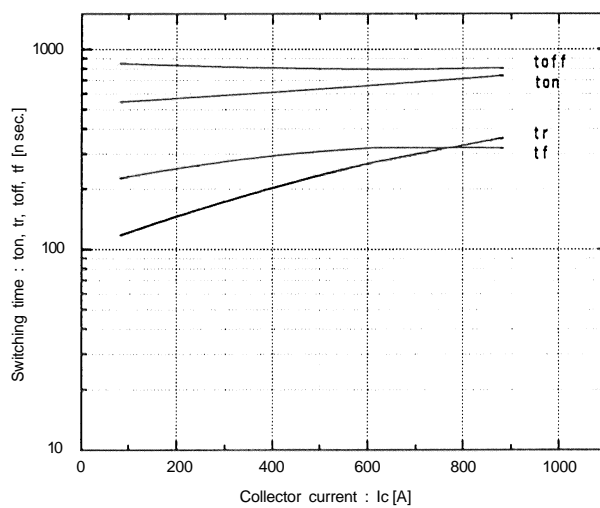

廢刊 秘種
 Discontinued product.

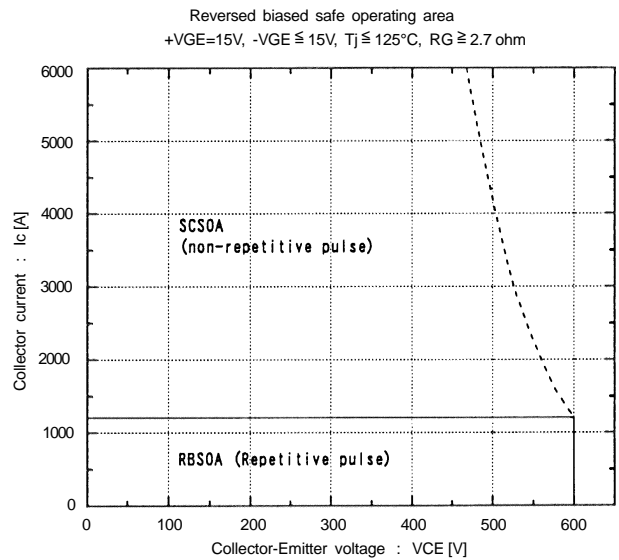
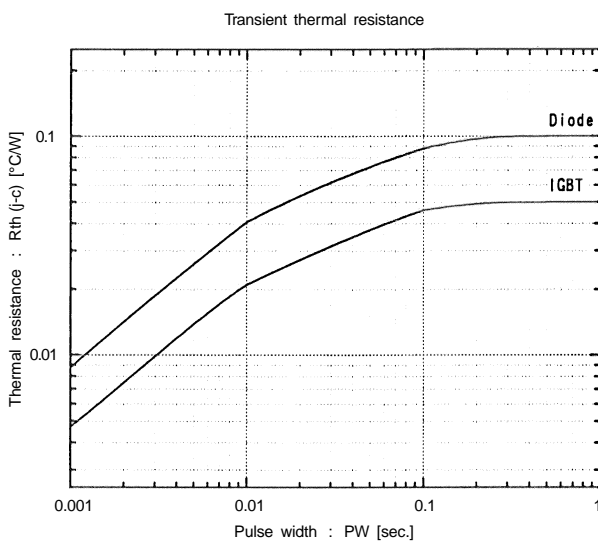
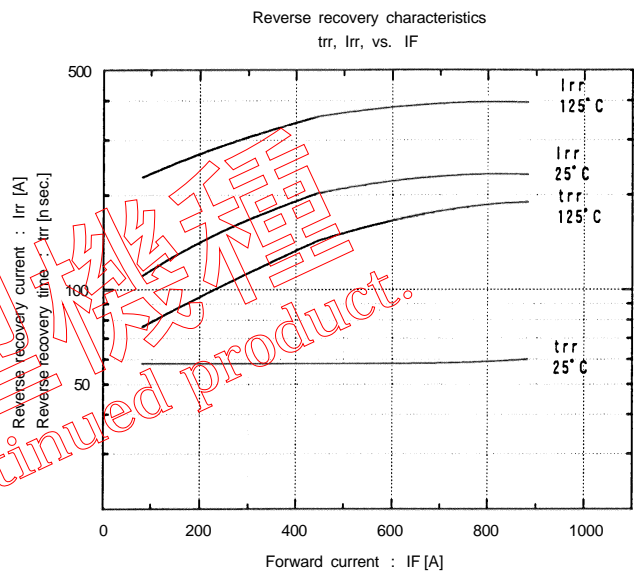
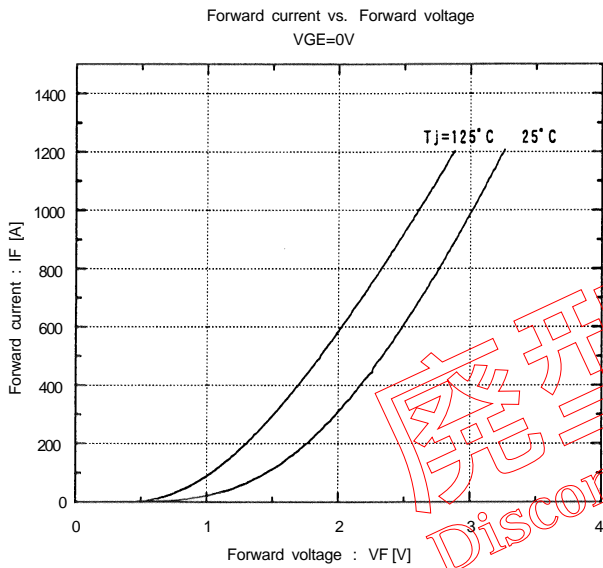
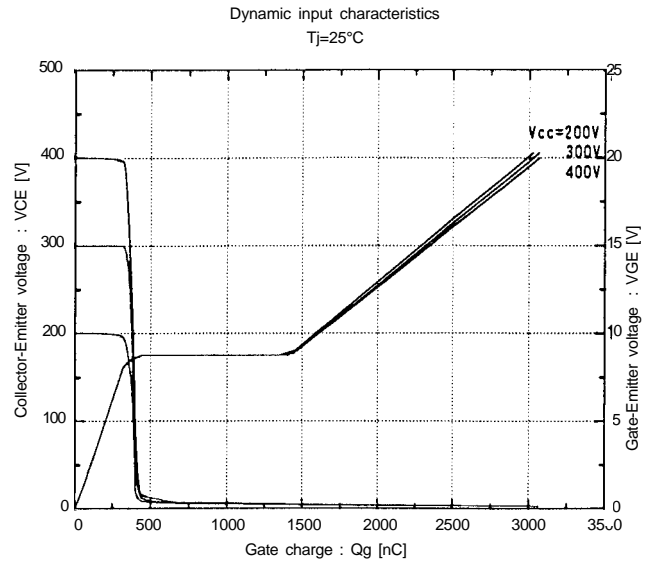
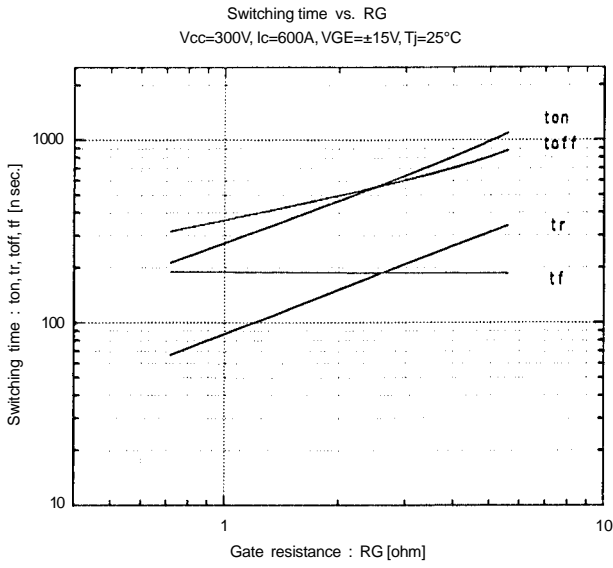

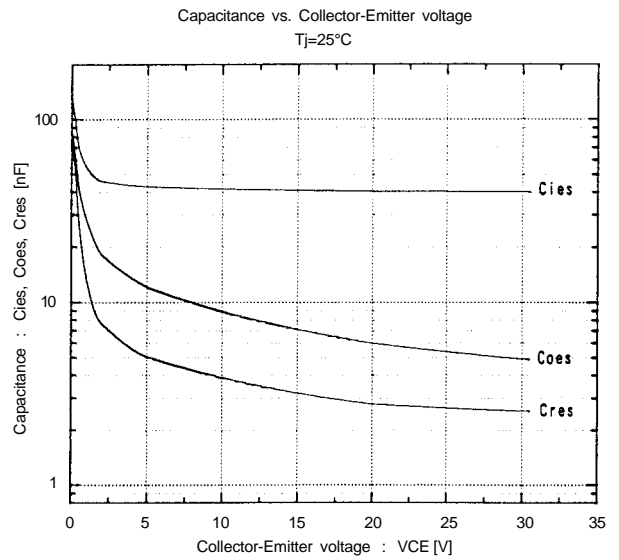
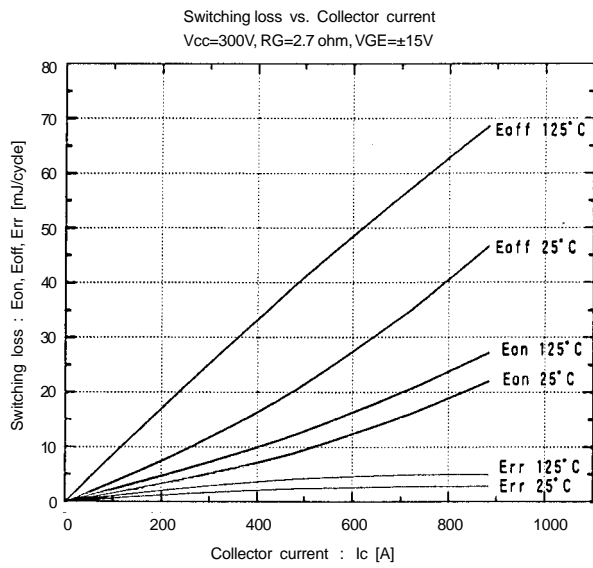

■ Outline Drawings, mm

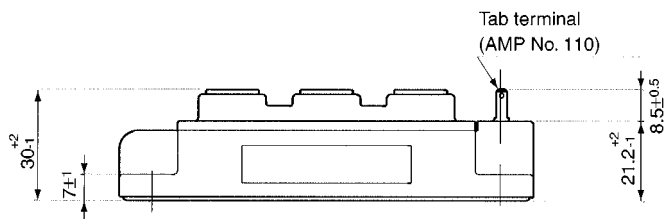
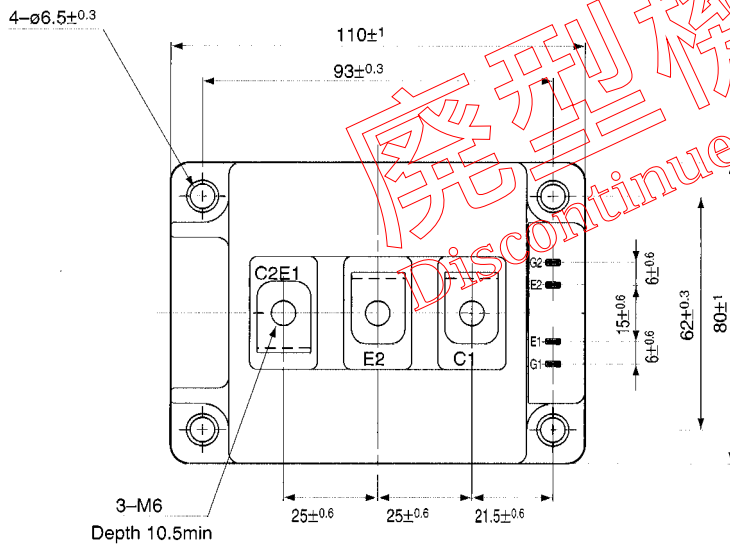

Mass : 470g