

IGBT MODULE (L series)

■ Features

- High Speed Switching
- Low Saturation Voltage
- Voltage Drive

■ Applications

- Inverter for Motor Drive
- AC and DC Servo Drive Amplifier
- Uninterruptible Power Supply
- Industrial Machines, such as Welding Machines

■ Maximum Ratings and Characteristics

● Absolute Maximum Ratings

Items	Symbols	Ratings	Units
Collector-Emitter Voltage	V _{CEs}	600	V
Gate-Emitter Voltage	V _{GES}	±20	V
Collector Current	Continuous	I _c	300
	1ms	I _{c pulse}	600
	Continuous	-I _c	300
	1ms	-I _{c pulse}	600
Max. Power Dissipation	P _c	1200	W
Operating Temperature	T _j	+150	°C
Storage Temperature	T _{stg}	-40 to +125	°C
Net. Weight		410	g
Isolation Voltage	AC. 1min.	V _{isol}	2500
Screw Torque	Mounting *1	35	kg*cm
	Terminals *2	45	

*1 Recommendable Value 25 to 35kg*cm (M5)
*2 Recommendable Value 35 to 40kg*cm (M4)

● Electrical Characteristics (T_j=25°C)

Items	Symbols	Test Conditions	Min.	Typ.	Max.	Units
Zero Gate Voltage Collector Current	I _{CEs}	V _{GE} =0V V _{CE} =600V T _j =25°C			4.0	mA
Gate-Emitter Leakage Current	I _{GES}	V _{CE} =0V V _{GE} =±20V			200	nA
Gate-Emitter Threshold Voltage	V _{GE(th)}	V _{CE} =20V I _c =300mA	3.0		6.0	V
Collector-Emitter Saturation Voltage	V _{CE(sat)}	V _{GE} =15V I _c =300A		2.7	3.5	V
Input Capacitance	C _{ies}	V _{GE} =0V		28500		pF
Output Capacitance	C _{oes}	V _{CE} =10V		-		
Reverse Transfer Capacitance	C _{res}	f=1MHz		-		
Turn-on Time *3	t _{on}	V _{CC} =300V		0.7	0.8	μs
	t _r	I _c =300A		0.4	0.6	
Turn-off Time *4	t _{off}	V _{GE} =±15V		0.7	1.0	
	t _f	R _G =6.8Ω		0.2	0.35	
Diode Forward On-Voltage	V _F	I _F =300A V _{GE} =0V			2.5	V
Reverse Recovery Time	t _{rr}	I _F =300A -di/dt=900A/μs V _{GE} =-10V			300	ns

*3 Resistive load *4 Inductive load

● Thermal Characteristics

Items	Symbols	Test Conditions	Min.	Typ.	Max.	Units
Thermal Resistance	R _{th(j-c)}	IGBT			0.104	°C/W
	R _{th(j-e)}	Diode			0.20	
	R _{th(c-f)}	With Thermal compound		0.025		

■ Outline Drawings

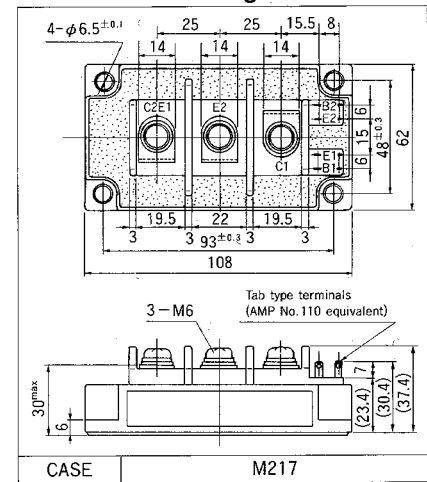

■ Equilavelent Circuit Schematic

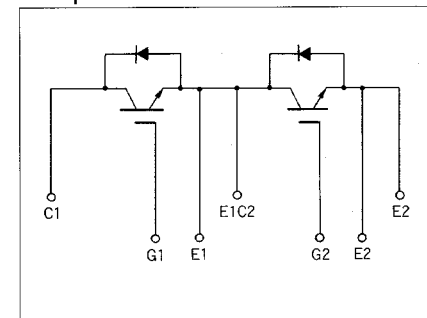

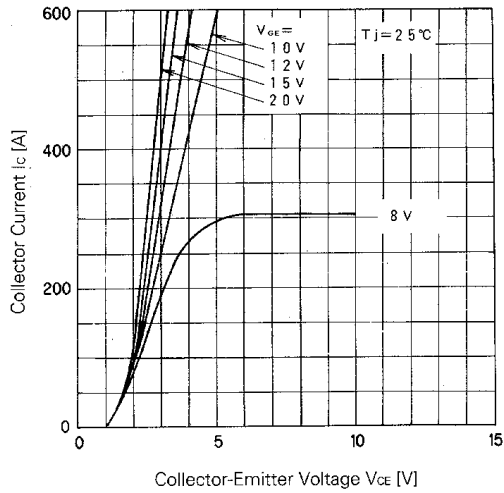

Collector Current vs. Collector-Emitter Voltage

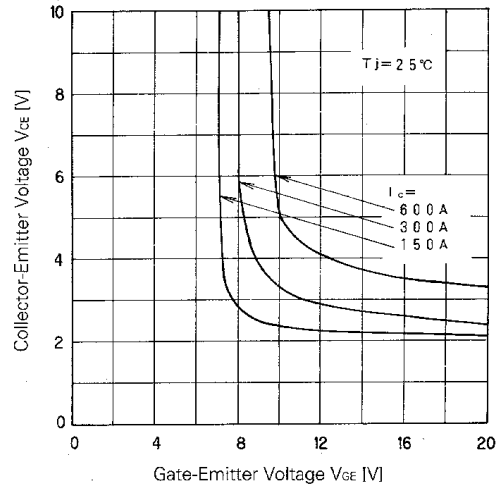

Collector-Emitter Voltage vs. Gate-Emitter Voltage

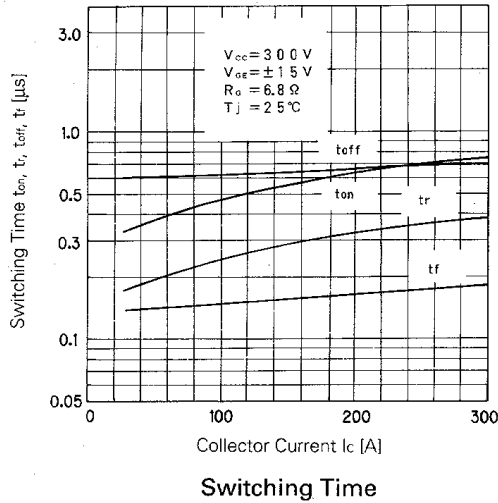

Switching Time

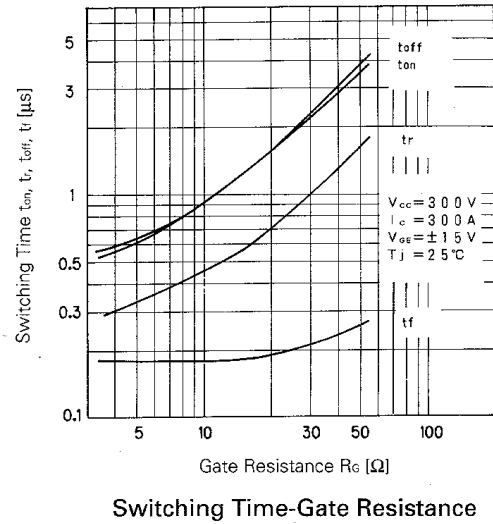

Switching Time-Gate Resistance

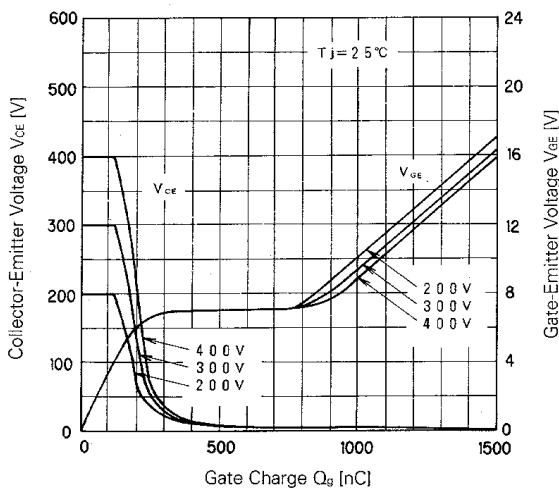

Dynamic Input Characteristic

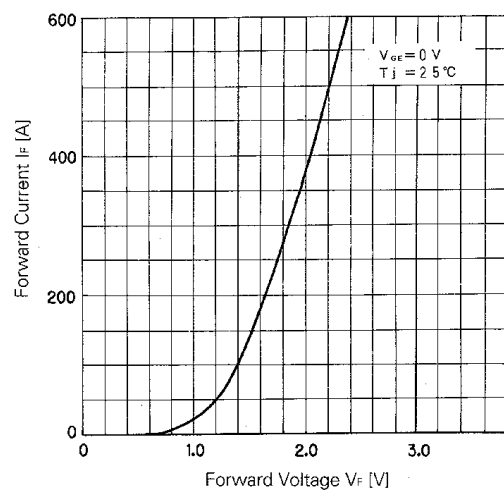

Forward Voltage of Free Wheel Diode

