

IGBT MODULE (F series)

■ Features

- Low Saturation Voltage
- Voltage Drive
- Variety of Power Capacity Series

■ Applications

- Inverter for Motor Drive
- AC and DC Servo Drive Amplifier
- Uninterruptible Power Supply
- Industrial Machines, such as Welding Machines

■ Maximum Ratings and Characteristics

● Absolute Maximum Ratings

Items	Symbols	Ratings	Units
Collector-Emitter Voltage	V_{CES}	600	V
Gate-Emitter Voltage	V_{GES}	± 20	V
Collector Current	Continuous	I_C	400
	1ms	$I_{C\ pulse}$	800
	Continuous	$-I_C$	400
	1ms	$-I_{C\ pulse}$	800
Max. Power Dissipation	P_C	1440	W
Operating Temperature	T_j	+150	$^{\circ}C$
Storage Temperature	T_{stg}	-40 to +125	$^{\circ}C$
Net. Weight		415	g
Isolation Voltage	AC, 1min.	V_{isol}	2500
Screw Torque	Mounting *1	3.5 {35}	N · m
	Terminals *2	4.5 {45}	(kg · cm)
	Terminals *3	1.7 {17}	

*1 Recommendable Value 2.5 to 3.5N·m {25 to 35 kg·cm} (M5)

*2 Recommendable Value 3.5 to 4.0N·m {35 to 40 kg·cm} (M6)

*3 Recommendable Value 1.3 to 1.6N·m {13 to 16 kg·cm} (M4)

● Electrical Characteristics (T_c=25°C)

Items	Symbols	Test Conditions	Min.	Typ.	Max.	Units
Zero Gate Voltage Collector Current	I_{CES}	$V_{GE}=0V\ V_{CE}=600V\ T_j=25^{\circ}C$			4.0	mA
		$V_{GE}=0V\ V_{CE}=600V\ T_j=125^{\circ}C$			—	mA
Gate-Emitter Leakage Current	I_{GES}	$V_{CE}=0V\ V_{GE}=\pm 20V$			400	nA
Gate-Emitter Threshold Voltage	$V_{GE(th)}$	$V_{CE}=20V\ I_C=400mA$	3.0		6.0	V
Collector-Emitter Saturation Voltage	$V_{CE(sat)}$	$V_{GE}=15V\ I_C=400A$			2.5	V
Input Capacitance	C_{ies}	$V_{GE}=0V$		38000		pF
Output Capacitance	C_{oes}	$V_{CE}=10V$		—		
Reverse Transfer Capacitance	C_{res}	$f=1MHz$		—		
Turn-on Time	t_{on}	$V_{CC}=300V$			0.8	μs
	t_r	$I_C=400A$			0.6	
Turn-off Time	t_{off}	$V_{GE}=\pm 15V$			1.5	
	t_f	$R_G=4.7\Omega$			1.0	
Diode Forward On-Voltage	V_F	$I_F=400A,\ V_{GE}=0V$			2.5	V
Reverse Recovery Time	t_{rr}	$I_F=400A,\ -di/dt=1200A/\mu s\ V_{GE}=-10V$			300	ns

● Thermal Characteristics

Items	Symbols	Test Conditions	Min.	Typ.	Max.	Units
Thermal Resistance	$R_{th(j-c)}$	IGBT			0.087	$^{\circ}C/W$
	$R_{th(j-c)}$	Diode			0.167	
	$R_{th(c-f)}$	With Thermal compound		0.0125		

■ Outline Drawings

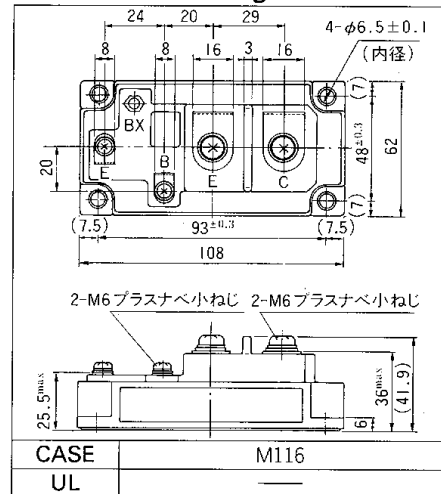

■ Equivalent Circuit Schematic

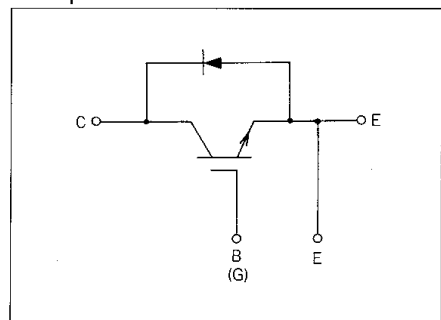

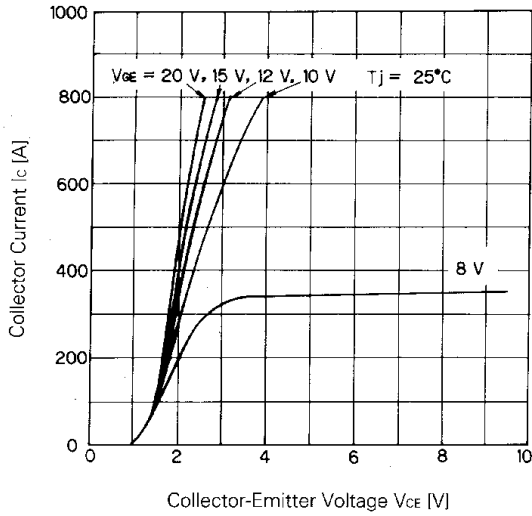

Collector Current vs. Collector-Emitter Voltage

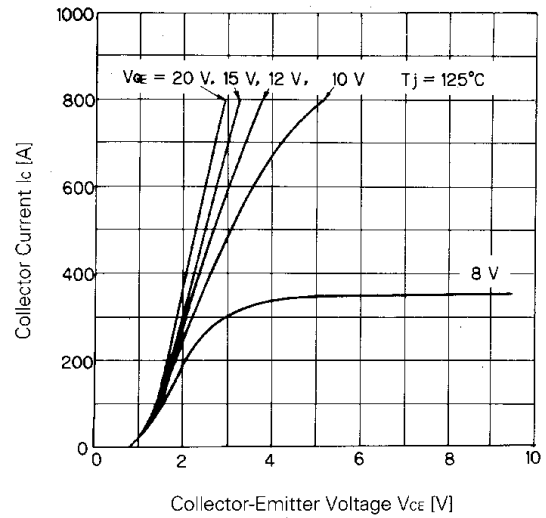

Collector Current vs. Collector-Emitter Voltage

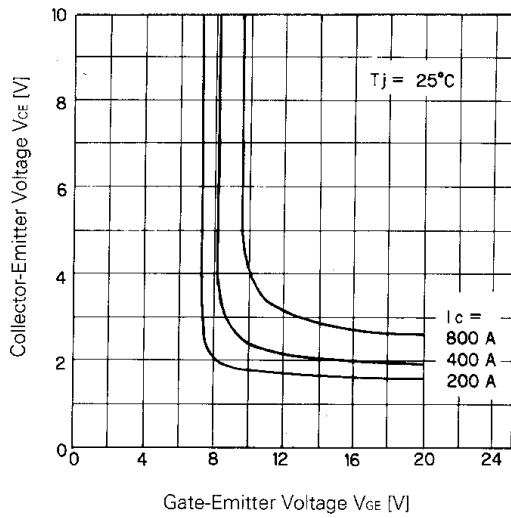

Collector-Emitter Voltage vs. Gate-Emitter Voltage

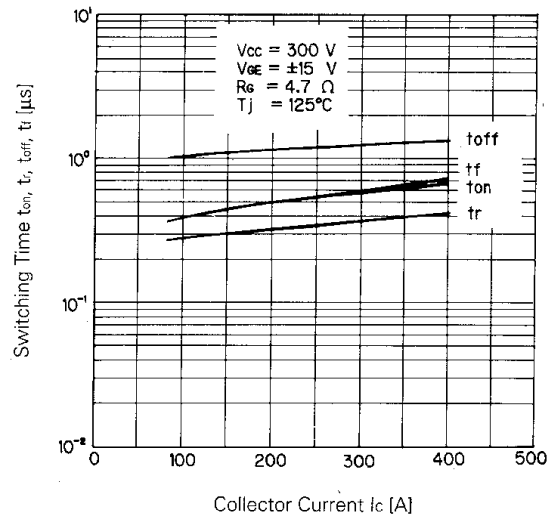

Switching Time

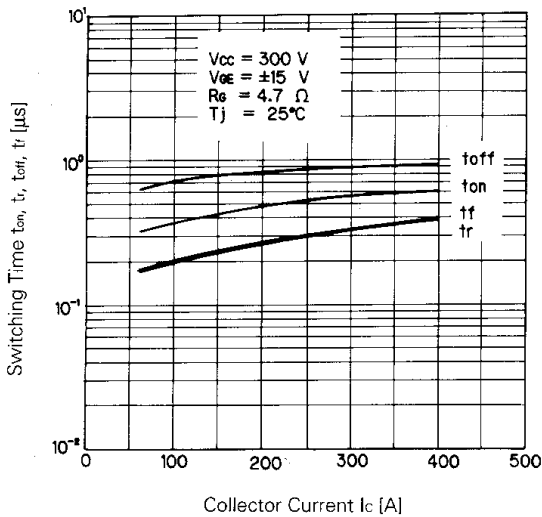

Switching Time

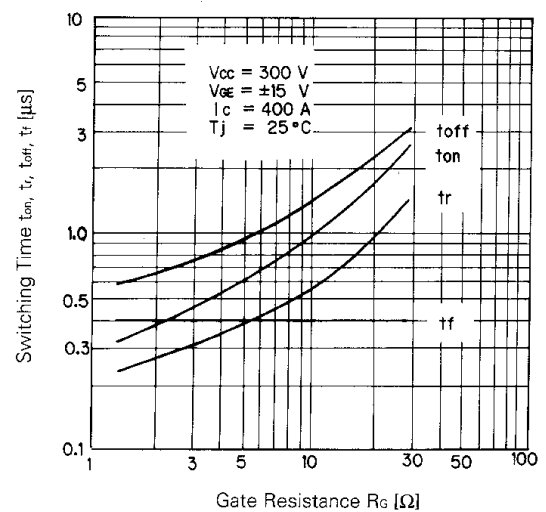

Switching Time-Gate Resistance

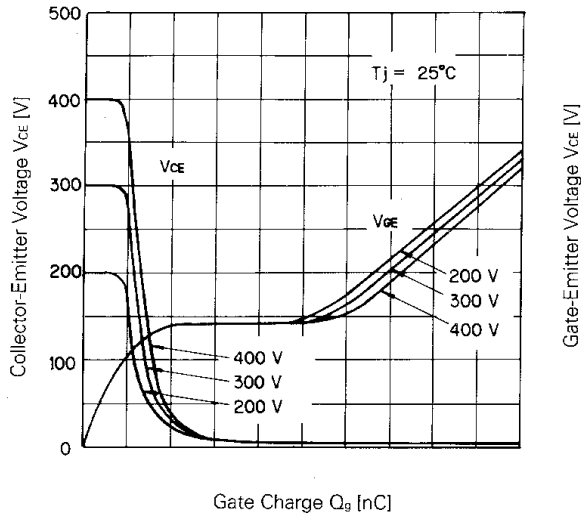

Dynamic Input Characteristic

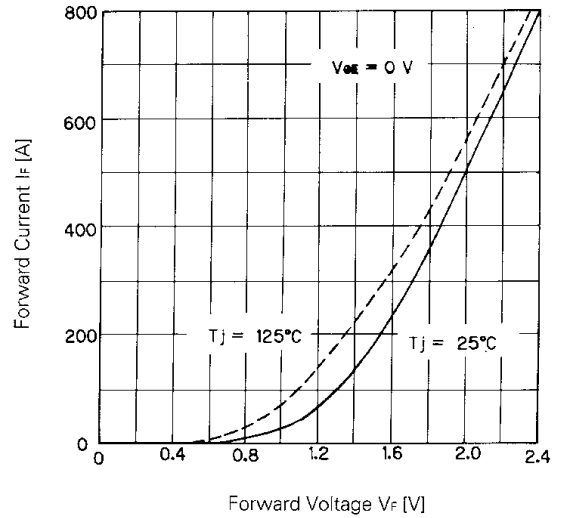

Forward Voltage of Free Wheel Diode

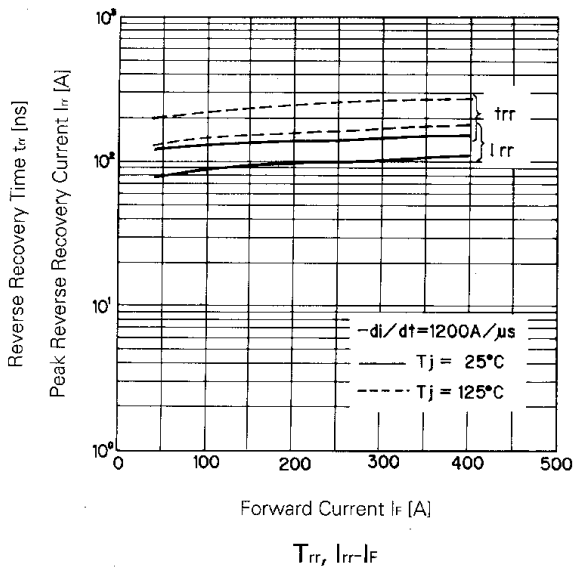

$T_{rr}, I_{rr}-I_f$

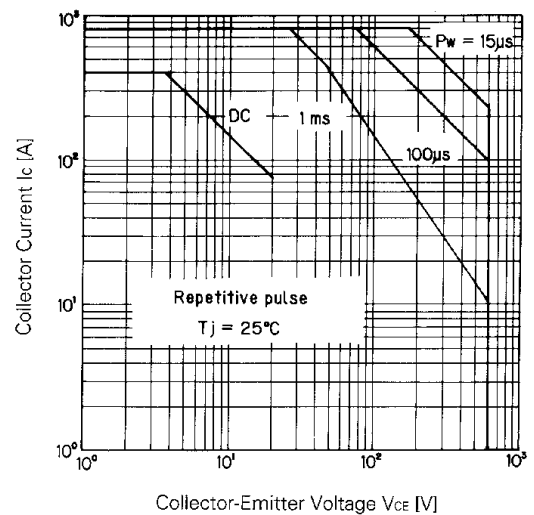

Safe Operating Area

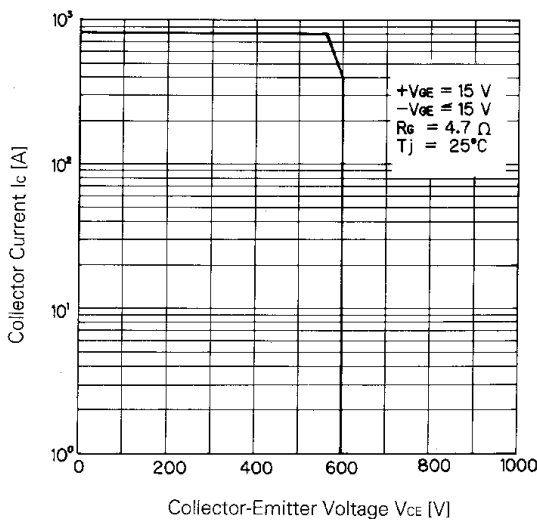

Reverse Biased Safe Operating Area

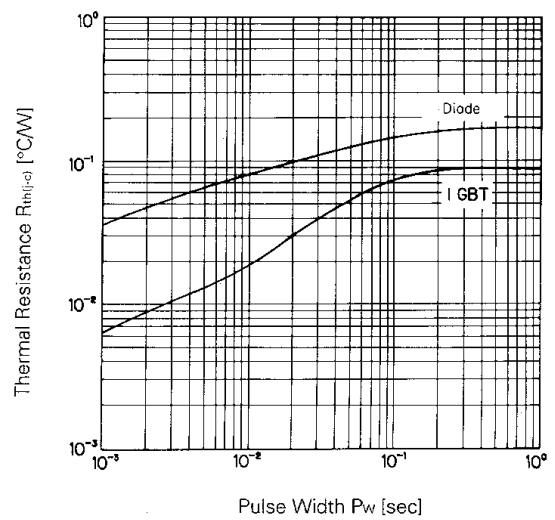

Transient Thermal Resistance