

Target Specification of 1MBI200S-120

1. Outline Drawing (Unit : mm)

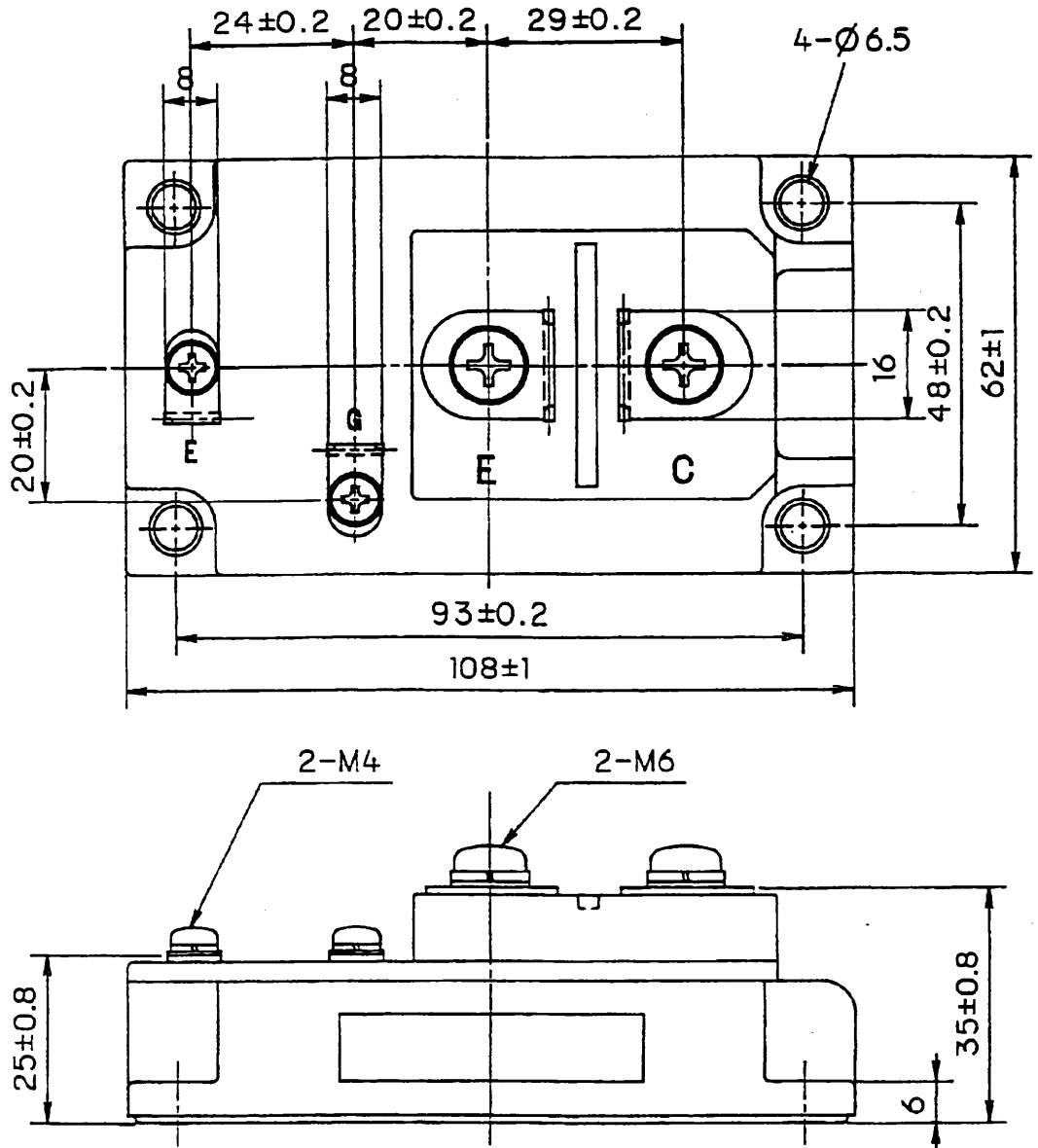

2. Equivalent circuit

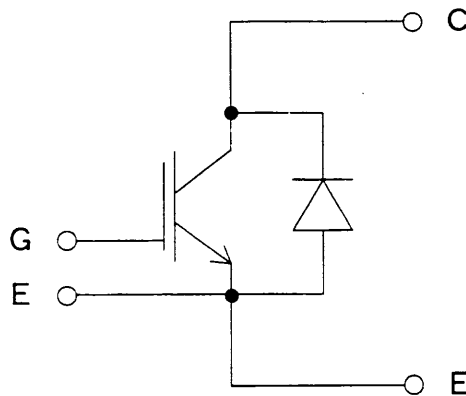

This material and the information herein is the property of Fuji Electric Co. Ltd. They shall be neither reproduced, copied, lent, or disclosed in any way whatsoever for the use of any third party nor used for the manufacturing purposes without the express written consent of Fuji Electric Co., Ltd.

REVISIONS	
-----------	--

DATE	NAME	APPROVED
DRAWN Feb -11 -99	N. Arakawa	
CHECKED Feb -11 -99	S. Hata	T. Miyazaki

Fuji Electric Co., Ltd.	
DWG. NO.	MT5F 9781 1/5

3. Absolute Maximum Ratings (at Tc= 25°C unless otherwise specified)

Items	Symbols	Conditions	Maximum Ratings	Units	
Collector-Emitter voltage	V _{CES}		1200	V	
Gate-Emitter voltage	V _{GES}		±20	V	
Collector current	I _c	Continuous	Tc=25°C	300	A
			Tc=80°C	200	
	I _c pulse	1ms	Tc=25°C	600	
			Tc=80°C	400	
			-I _c	200	
-I _c pulse	1ms	400			
Collector Power Dissipation	P _c	1 device	1300	W	
Junction temperature	T _j		150	°C	
Storage temperature	T _{stg}		-40~ +125	°C	
Isolation voltage ^(#1)	V _{iso}	AC : 1min.	2500	V	
Screw Torque	Mounting ^(#2)		3.5	N·m	
	Terminals ^(#3)		4.5		
	Terminals ^(#4)		1.7		

(#1) All terminals should be connected together when isolation test will be done.

(#2) Recommendable Value : 2.5~3.5 N·m (M5) or (M6)

(#3) Recommendable Value : 3.5~4.5 N·m (M6)

(#4) Recommendable Value : 1.3~1.7 N·m (M4)

4. Electrical characteristics (at Tj= 25°C unless otherwise specified)

Items	Symbols	Conditions	Characteristics			Units
			min.	typ.	Max.	
Zero gate voltage Collector current	ICES	V _{GE} = 0 V, V _{CE} = 1200 V			4.0	mA
Gate-Emitter leakage current	IGES	V _{CE} = 0 V, V _{GE} = ±20 V			0.8	μA
Gate-Emitter threshold voltage	V _{GE(th)}	V _{CE} = 20 V, I _c = 200 mA	5.5	7.2	8.5	V
Collector-Emitter saturation voltage	V _{CE(sat)}	V _{GE} = 15 V, T _j = 25 °C		2.3	2.6	V
		I _c = 200 A, T _j = 125 °C		2.8		
Input capacitance	C _{ies}	V _{GE} = 0 V		24000		pF
Output capacitance	C _{oes}	V _{CE} = 10 V		5000		
Reverse transfer capacitance	C _{res}	f = 1 MHz		4400		
Turn-on time	t _{on}	V _{cc} = 600 V			1.2	μs
	t _r	I _c = 200 A			0.6	
	t _{r(1)}	V _{GE} = ±15 V		0.1		
Turn-off time	t _{off}	R _G = 4.7 Ω			1.0	μs
	t _f			0.08	0.3	
Forward on voltage	V _F	I _F = 200 A, T _j = 25 °C		2.4	3.3	V
		T _j = 125 °C		2.0		
Reverse recovery time	t _{rr}	I _F = 200 A			0.35	μs

5. Thermal resistance characteristics

Items	Symbols	Conditions	Characteristics			Units
			min.	typ.	Max.	
Thermal resistance (1 device)	R _{th(j-c)}	IGBT			0.096	°C/W
		FWD			0.260	
Contact Thermal resistance	R _{th(c-f)}	with Thermal Compound ^(*)		0.0125		

* This is the value which is defined mounting on the additional cooling fin with thermal compound.

Note :

- This specification is only for technical considerations, and not for contract.
- This specification is subject to be changed without notices.

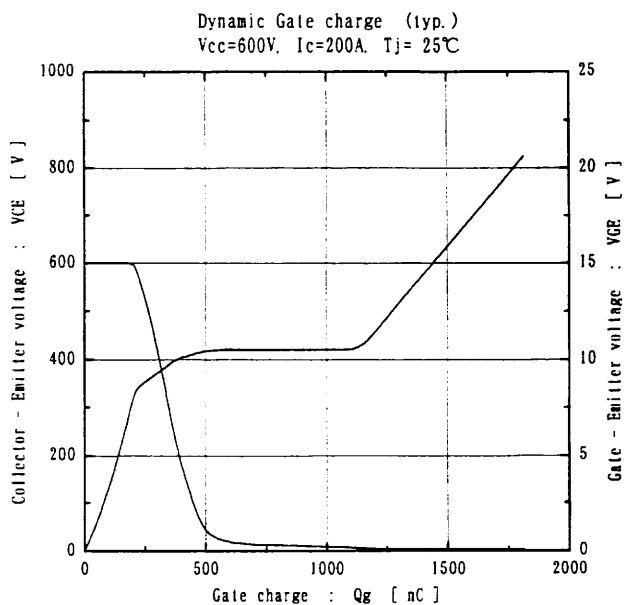
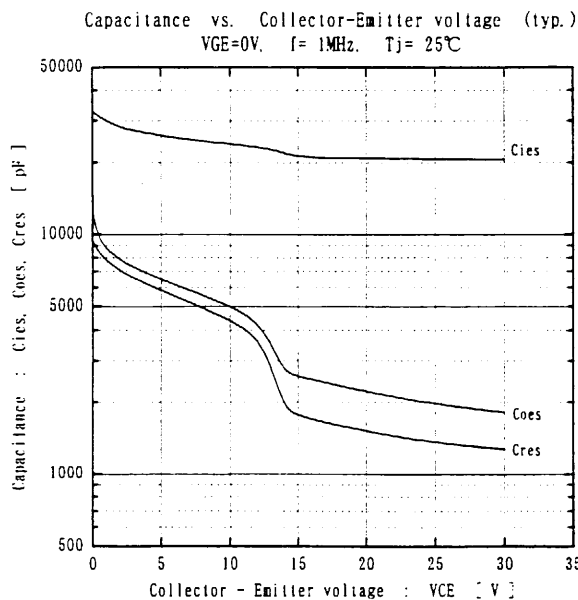
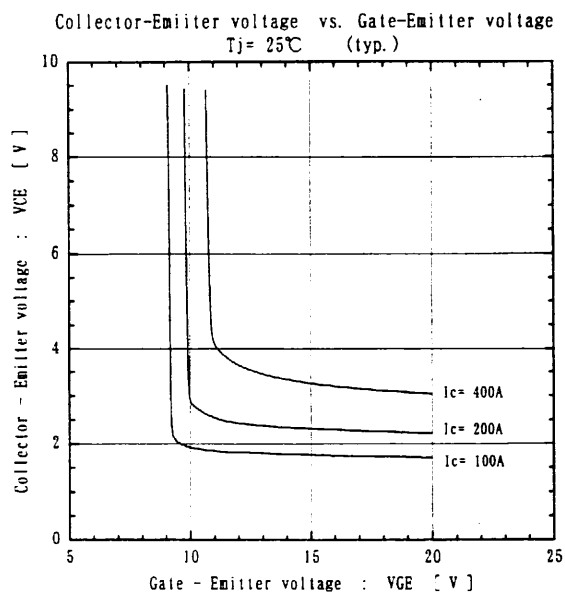
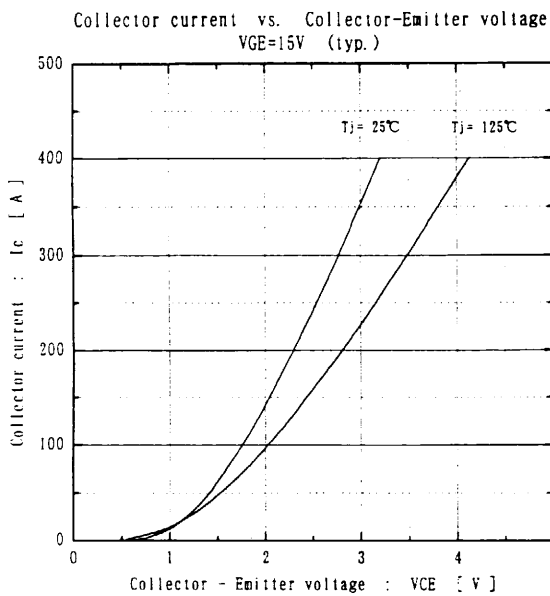
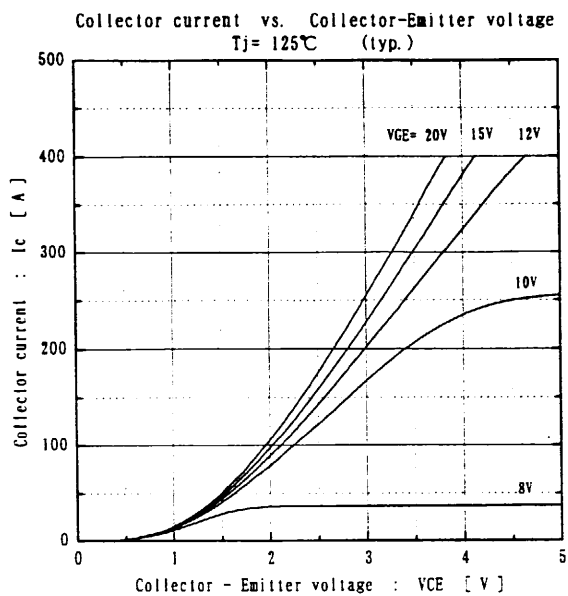
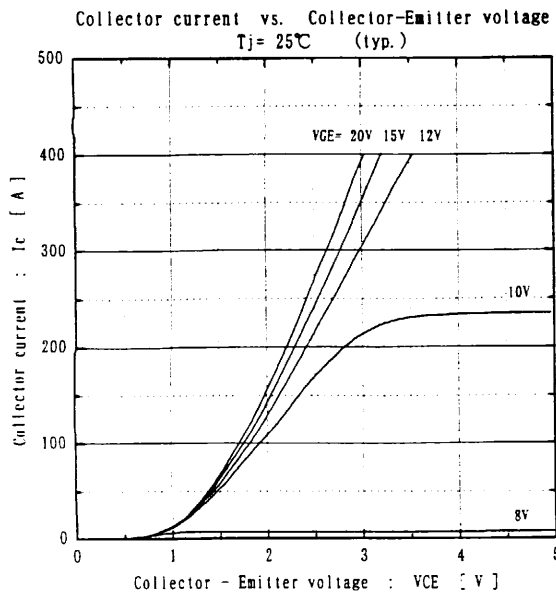

This material and the information herein is the property of Fuji Electric Co. Ltd. They shall be neither reproduced, copied, lent, or disclosed in any way whatsoever for the use of any third party nor used for the manufacturing purposes without the express written consent of Fuji Electric Co., Ltd.

This material and the information herein is the property of Fuji Electric Co. Ltd. They shall be neither reproduced, copied, lent, or disclosed in any way whatsoever for the use of any third party nor used for the manufacturing purposes without the express written consent of Fuji Electric Co., Ltd.

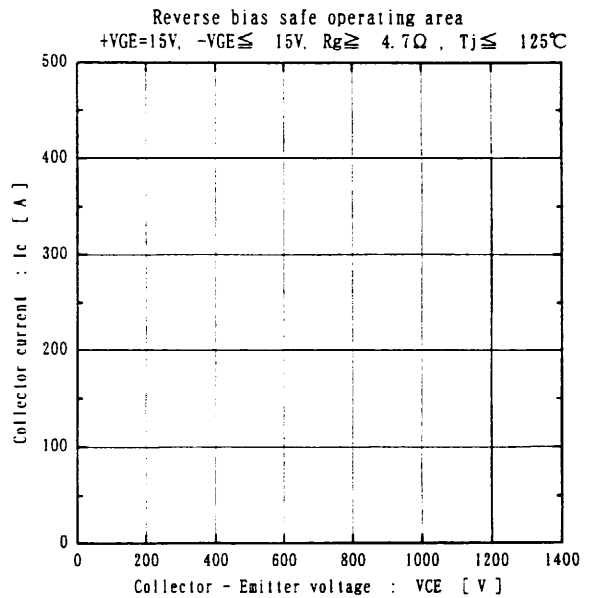
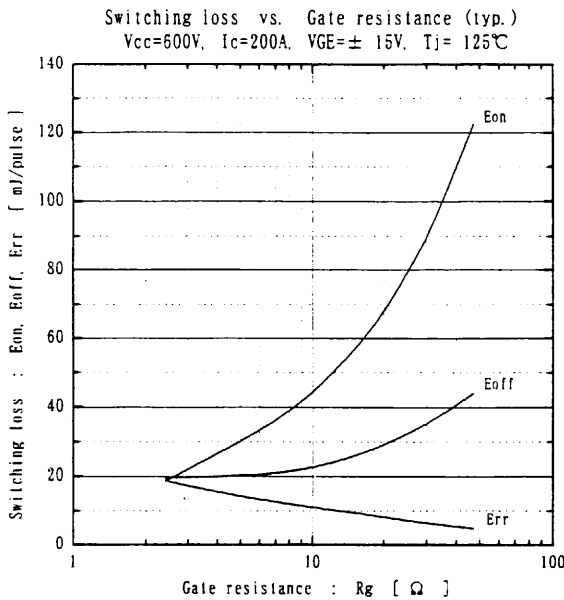
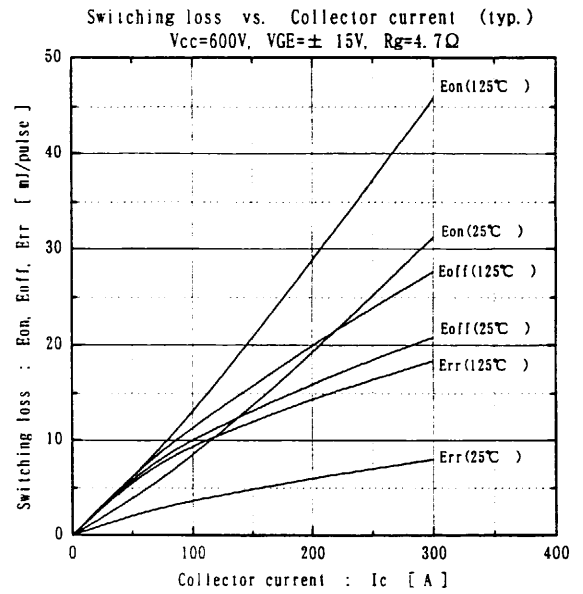
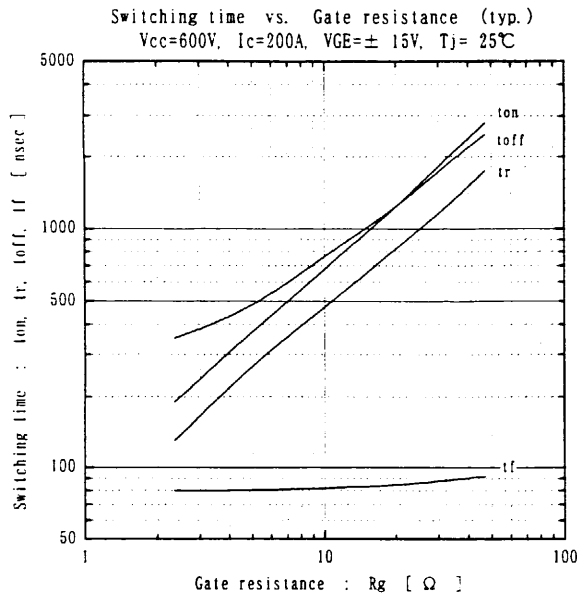
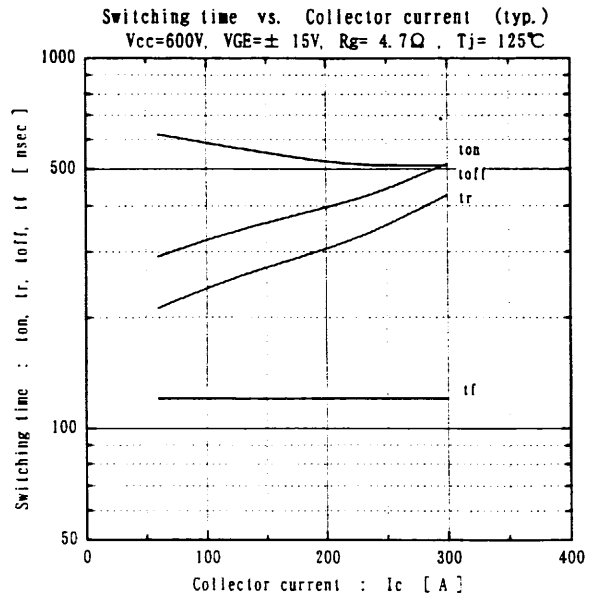
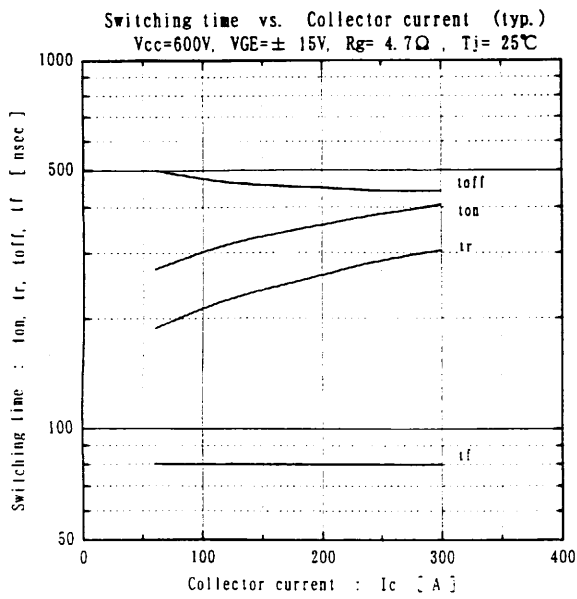

REVISIONS

Fuji Electric Co., Ltd.

DWG. NO. MT5F 9781

4/5

Forward current vs. Forward on voltage (typ.)

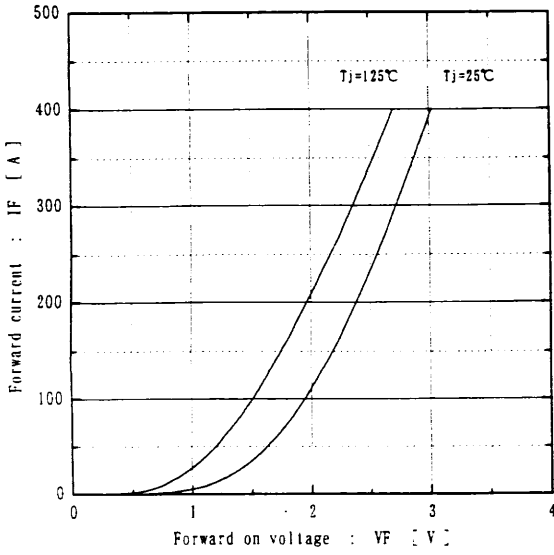

Reverse recovery characteristics (typ.)
Vcc=600V, VGE=±15V, Rg=4.7Ω

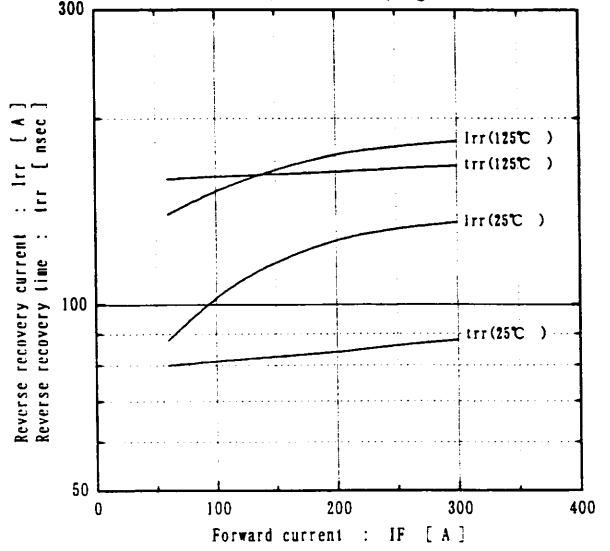

Transient thermal resistance

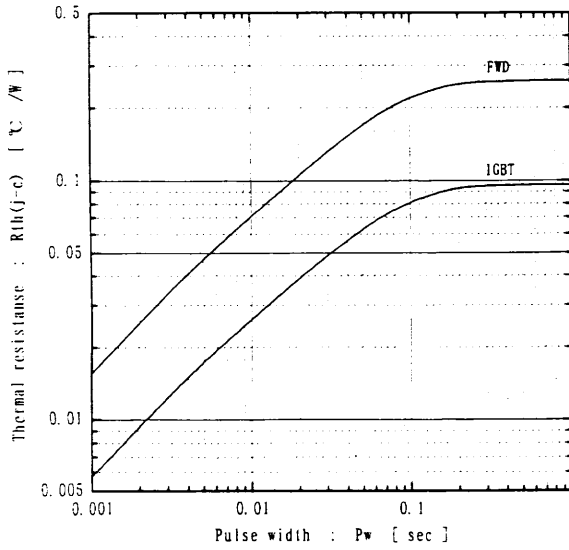

Definitions of switching time

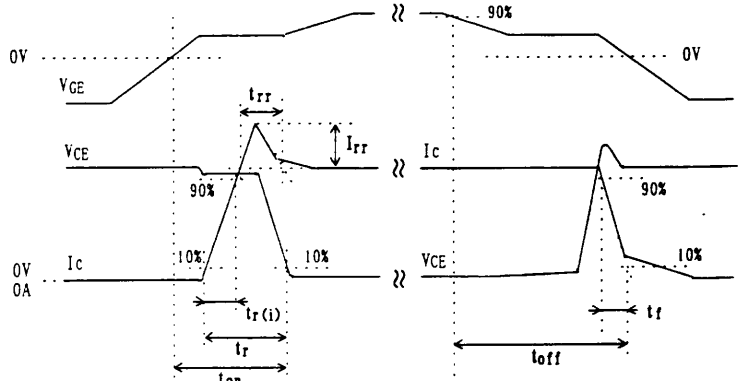
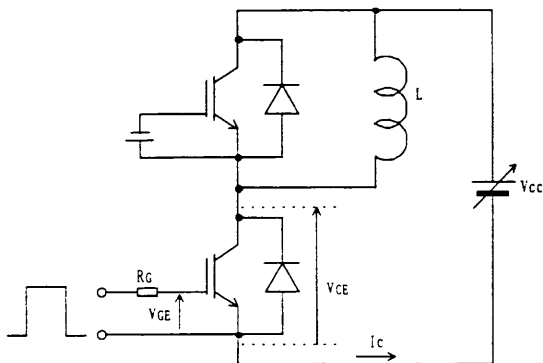

This material and the information herein is the property of Fuji Electric Co. Ltd. They shall be neither reproduced, copied, lent, or disclosed in any way whatsoever for the use of any third party nor used for the manufacturing purposes without the express written consent of Fuji Electric Co., Ltd.

REVISIONS

Fuji Electric Co., Ltd.

DWG. NO. MT5F 9781

5/5